

CBA750

PRODUCT MANUAL

Mobile Broadband Adapter 3G/4G Ready



for additional information, visit:

knowledgebase.cradlepoint.com

Preface

CradlePoint reserves the right to revise this publication and to make changes in the content thereof without obligation to notify any person or organization of any revisions or changes.

Manual Revisions

Revision	Date	Description	Author
1.0	June 7, 2010	Initial release for Firmware version 1.6.9	David Rush

Trademarks

CradlePoint and the CradlePoint logo are registered trademarks of CradlePoint, Inc. in the United States and other countries. All other company or product names mentioned herein are trademarks or registered trademarks of their respective companies.

Copyright © 2010 by CradlePoint, Inc.

All rights reserved. This publication may not be reproduced, in whole or in part, without prior expressed written consent by CradlePoint, Inc.

Table of Contents

1	INTRODUCTION	2	6.4	SYSLOG.....	37
1.1	PACKAGE CONTENTS	2	6.5	SYSTEM (SYSTEM SETTINGS)	38
1.2	SYSTEM REQUIREMENTS	2	6.6	SYSTEM CHECK (PING TEST)	39
1.3	CBA750 OVERVIEW	2	6.7	TIME	40
2	HARDWARE OVERVIEW	4	7	STATUS TAB	42
2.1	PORTS	5	7.1	DEVICE INFO.....	43
2.2	LEDs.....	6	7.2	LOGS.....	46
3	QUICK START	7	7.3	STATISTICS (TRAFFIC STATISTICS)	47
3.1	SETTING UP YOUR ADAPTER	7	8	GLOSSARY	48
3.2	FIRMWARE FEATURES.....	7	9	APPENDIX	59
3.3	COMMON PROBLEMS.....	8	9.1	REGULATORY INFORMATION	59
4	ADMINISTRATIVE TABS AND SUB-MENUS	10	9.2	WARRANTY INFORMATION	59
4.1	BASIC TAB.....	11	9.3	SPECIFICATIONS.....	60
4.2	IP PASS-THRU.....	12			
4.3	DHCP (DHCP SETTINGS)	13			
4.4	NETWORK	18			
4.5	WAN CONFIGURATION	20			
5	MODEM TAB	21			
5.1	INFO	22			
5.2	FAILOVER	23			
5.3	SETTINGS	25			
5.4	UPDATE	30			
6	TOOLS TAB	31			
6.1	ADMIN (ADMINISTRATIVE SETTINGS).....	32			
6.2	FIRMWARE	33			
6.3	MANAGED SERVICES	36			

1 INTRODUCTION

1.1 Package Contents

- CradlePoint CBA750 3G/4G Mobile Broadband Adapter
- AC power adapter (12V, 1.5A) **WARNING:** using a power adapter other than the one provided may damage the CBA750 and will void the warranty
- Mounting Hardware
- CAT5 Ethernet Cable
- Quick Start Guide

1.2 System Requirements

- Broadband Data Modem(s) with Active Subscription (USB, ExpressCard).
- Management Interface Requires an Internet Browser: Internet Explorer v6.0 or higher, Firefox v2.0 or higher, Safari v1.0 or higher.

1.3 CBA750 Overview

- Drop-In, Easy To Use Adapter – No Software To Install
- Compatible with 100+ EVDO, HSPA, and WiMAX Mobile Broadband Network Devices (3G/4G)
- Power-over-Ethernet allows you to place the CBA750 in the Best Location
- 10/100 BASE-T Ethernet Port
- IEEE 802.u Compliant – Supports Dynamic IP and Static IP
- Universal Plug-n-Play and Application-Level Gateway for Internet Applications: Email, FTP, Gaming, Remote Desktop, NetMeeting, Telnet, SSH, and SCP
- Flash Memory for Firmware Upgrades and Save/Restore Settings
- Easy Local or Remote Management via HTTP and HTTPS
- Full Integration with WiPipe™ Central (Optional Manage Services from CradlePoint)

1.3.1 Connectivity Made Simple

The CradlePoint CBA750 3G/4G Mobile Broadband Adapter provides IP Pass-Through capabilities for a device that requires wireless broadband access. For most applications, simply connect the CBA750, turn the unit on, and it's ready to go. Quick to install, the CBA750 handles the connection without configuration and provides enhanced network connectivity with support for USB and Express-Card modems running on 3G/4G Networks. Adding a wireless backup or even primary connection has never been easier.

1.3.2 Powerful, Reliable, Convenient

As a high-performance adapter, the CBA750 supports multiple and concurrent application streams for the attached device, converting Ethernet to mobile broadband and mobile broadband to Ethernet. This flexible connectivity solution is platform independent, features two operating modes (configuration and IP Pass-Through), and has an “always-on” signal strength meter to determine the best mobile broadband reception for optimum placement. The CBA750 is truly a “drop-in” 3G/4G solution for adding mobile broadband capability effortlessly.

1.3.3 How Is It Used?

The CradlePoint CBA750 3G/4G Mobile Broadband Adapter can be used in three main ways:

- **As Primary Connection** in “remote, lights-out” devices like kiosks, ATMs, digital signage, and point of sale devices.
- **As Failover** connection for network equipment that supports redundant WANs.
- **As Antenna Remoting** which allows you to get the best 3G/4G signal available by placing the CBA750 in the best location for receiving the signal. From Power-over-Ethernet, you can take advantage of existing CAT5 cabling within a building.

2 HARDWARE OVERVIEW



2.1 Ports

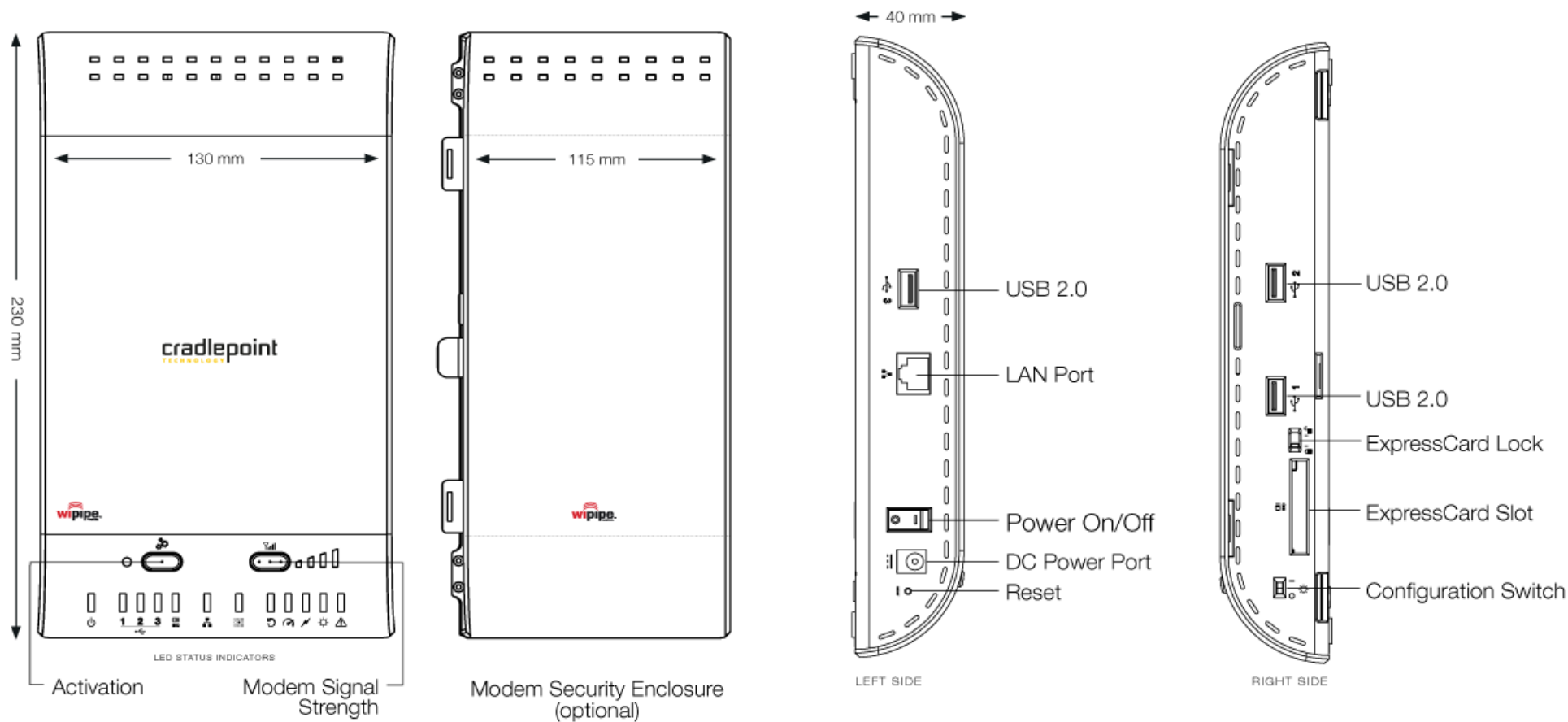

2.2 LEDs

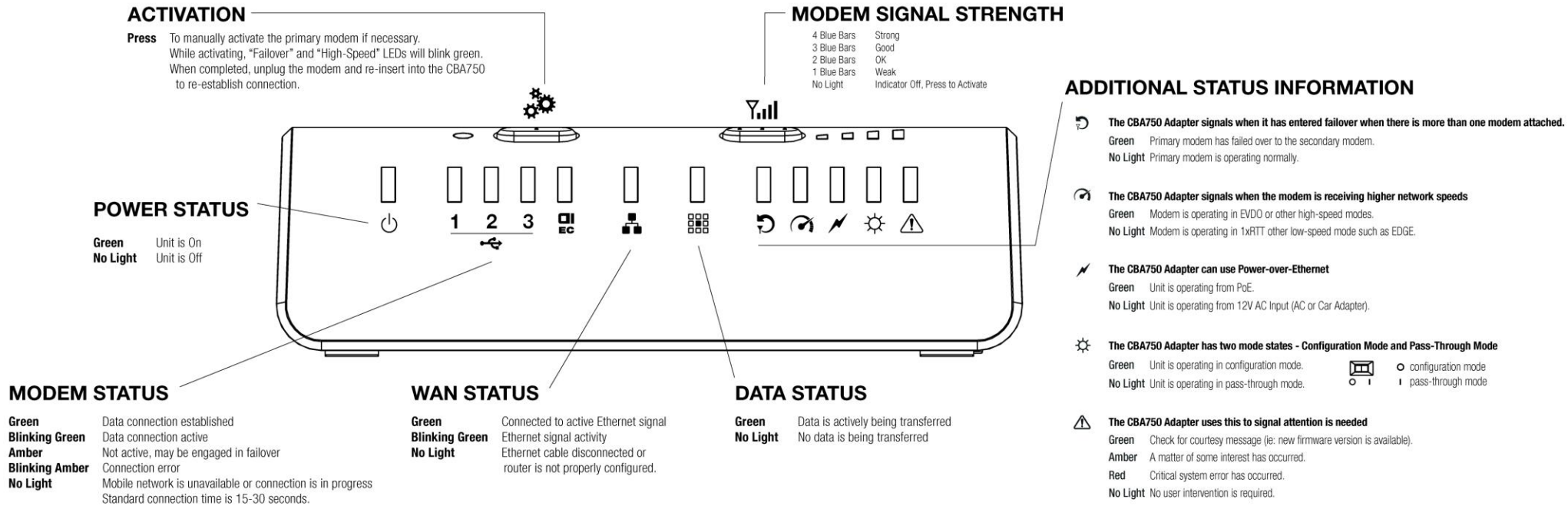

3 QUICK START

3.1 Setting Up Your Adapter

- Connect Mobile Broadband Device – Plug a USB or ExpressCard data modem into the appropriate slot. The data modem should have an active data plan.
- Place CBA750 Adapter in Best Signal Location – Use Modem Signal Strength display to find the best location for the CBA750 Adapter. Use provided mounting hardware if desired.
- Connect to a Router or Switch – Plug the Ethernet cable into a routing device or switch.
- Connect Power Supply – Connect the included power adapter if not using Power-over-Ethernet (PoE).

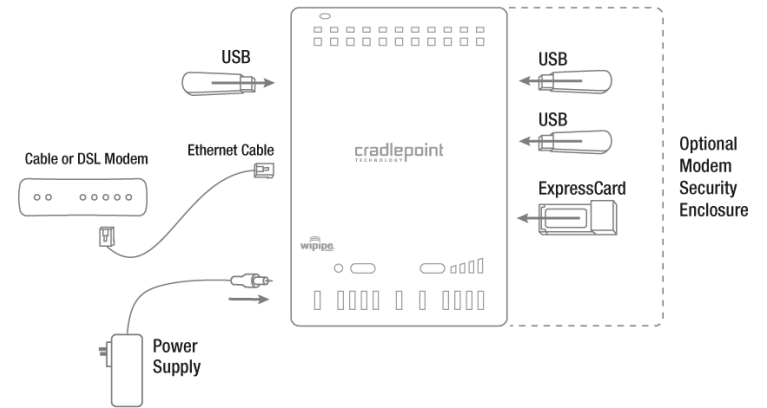

For most users, the CBA750 Adapter can be used without configuration. When needed, set the Configuration switch to “O” to place the unit into configuration mode.

Configuration mode is used to set up user parameters, download new firmware, and enable cellular modem diagnostics by accessing the administration page at <http://192.168.0.1>

3.2 Firmware Features

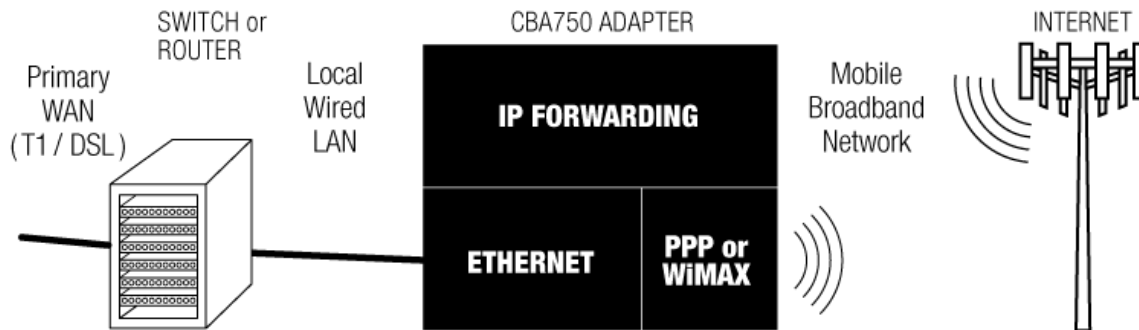

- WAN Connectivity Is Via Mobile Broadband Modem Only.
- IP Pass-Through is from a Mobile Broadband Modem to local wired Ethernet.
- Only one machine on the local Ethernet interface is supported. This client receives the IP address assigned to the PPP link's local address.
- The adapter is modal: it has pass-through mode and a configuration mode. ⚙️ Changing between modes is done by changing the configuration switch setting.
- The adapter implements the PPP protocol for communication over the Mobile Broadband network. Security parameters can be configured via the CBA750 Administration Page.

3.3 Common Problems

This section contains a list of some of the most common issues faced by users of the CBA750.

Please visit CradlePoint Knowledgebase at <http://knowledgebase.cradlepoint.com/> for more help and answers to your other questions.

3.3.1 Your USB Modem or Phone Does Not Work With the Router

- If your USB data modem or phone is not working with the router, check the list of supported devices to ensure you are using a supported device and carrier. The device you're using must be supported on the carrier network providing your cellular service or it's considered an unsupported device, even if it is supported on another carrier's network.
CradlePoint's supported device list changes regularly. We update our supported device list after a device is certified and approved. If the device you have is NOT on the list, that means we do not support it at this time.
The SUPPORTED DEVICE list can be found at: cradlepoint.com/support/CBA750
- Sometimes a USB data modem needs to be updated or have other configurations set correctly in order to make a connection through the router. If your USB Modem has not been updated recently, it is recommended that you do so if it is having trouble connecting to the CBA750. Simply insert your USB data modem into your PC and using the software provided by your cellular carrier, access the Internet. Follow the directions provided to complete the update. Once you have updated your USB data modem, reconnect the cellular device to your CradlePoint router and connect to the Internet.
- If you are using 4G modem you need to set the WiMAX Realm. This can be done at the administrative page (login to IP address <http://192.168.0.1>) and go to **Modem → Settings**. Under Modem Specific Settings use the **WiMAX Realm Select** to select your carrier. Make sure you Save Settings.
- Some wireless carriers provide multiple Access Point Names that a modem can connect to. If you wish to specify an APN, this can be done at the administrative page (login to IP address <http://192.168.0.1>) and go to **Modem → Settings**. Enter the APN and **Save Settings**. Some examples of APN are isp.cingular, ecp.tmobile.com and vpn.com. This APN will be set in the first profile position (see **Modem Diagnostics**). The modem must be removed and reinserted for this change to take affect (or the router rebooted). This APN is associated with the modem in the interface referred to in the **Modem Interface** drop down menu, so multiple APNs may be entered.
- If the above issues have been resolved and you can connect to the router but not get internet through it using your modem you may need to upgrade the router firmware. Use your computer (you may need to plug your modem directly into your computer if you don't have another way to access the internet) to download the latest firmware for the router (found at: www.cradlepoint.com/support/CBA750). Then login to the router admin page and manually upload the firmware (directions can be found in this manual in section 6.2.2).
- If you are still unable to access the Internet after following the above directions, contact CradlePoint Technical Support for further assistance.

3.3.2 You are Connected to the Router but Cannot Connect to the Internet

The status LEDs of your router will give you an indication whether or not a proper connection is being made. See the LED STATUS definitions below:

If the USB Data Modem LEDs are not illuminated, your modem is not connected and online. You may need to update firmware. Refer to “Your USB Modem or Phone Does Not Work With The Router.”

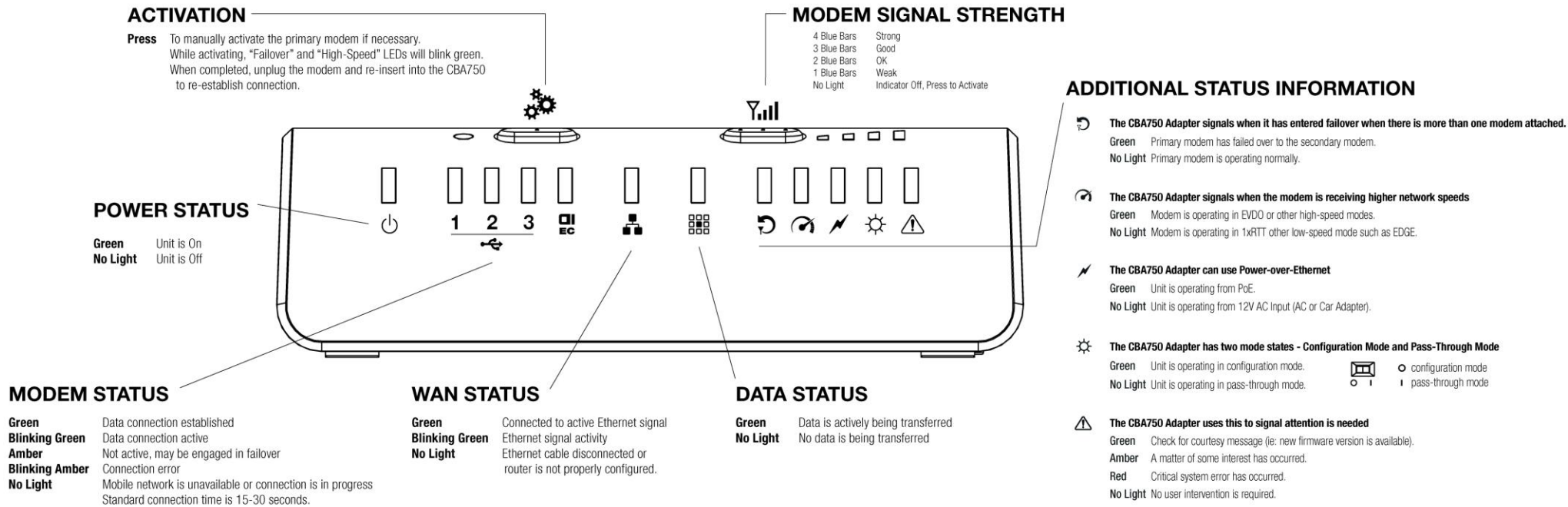

If you are still not online after updating, call CradlePoint Technical Support for further assistance.

4 ADMINISTRATIVE TABS AND SUB-MENUS

The CBA750 has a Web interface that provides a set of tabs and sub-menus for configuration and administration of all features. The interface is organized with 5 tabs at the top of the screen.

- Basic
- Modem
- Tools
- Status
- Help

Within each of the 5 tabs, there are sub-menus along the left side of the web page that you use to navigate to the specific function/task you wish to manage.



				
BASIC	MODEM	TOOLS	STATUS	HELP
Basic	Modem	Tools	Status	Help
IP PASSTHRU	INFO	ADMIN	DEVICE INFO	MENU
DHCP	FAILOVER	FIRMWARE	LOGS	BASIC
NETWORK	SETTINGS	MANAGED SERVICES	STATISTICS	MODEM
WAN	UPDATE	SYSLOG		TOOLS
		SYSTEM		STATUS
		SYSTEM CHECK		GLOSSARY
		TIME		

BASIC

4.1 Basic Tab

The Basic tab provides access to the 5 sub-menus for administering the following function/tasks:

- IP PASSTHRU
- DHCP
- NETWORK
- WAN

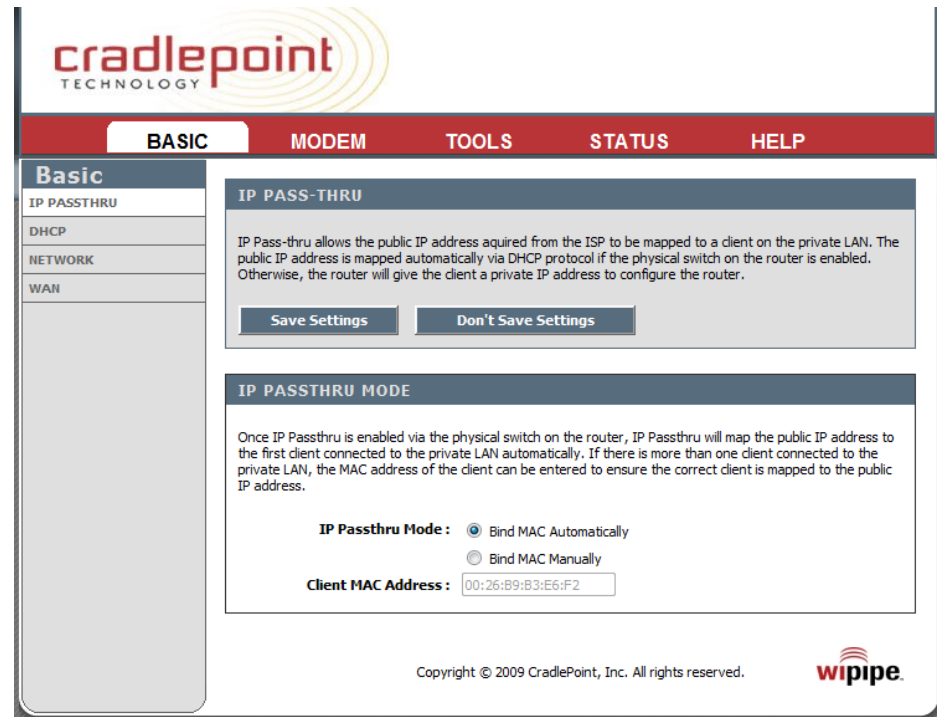

The screenshot shows the Cradlepoint web interface. At the top is the Cradlepoint Technology logo. Below it is a navigation bar with tabs: BASIC, MODEM, TOOLS, STATUS, and HELP. The BASIC tab is selected. On the left is a sidebar menu with options: Basic, IP PASSTHRU, DHCP, NETWORK, and WAN. The main content area is titled "IP PASS-THRU" and contains the following text: "IP Pass-thru allows the public IP address acquired from the ISP to be mapped to a client on the private LAN. The public IP address is mapped automatically via DHCP protocol if the physical switch on the router is enabled. Otherwise, the router will give the client a private IP address to configure the router." Below this text are two buttons: "Save Settings" and "Don't Save Settings".

Below the first section is another section titled "IP PASSTHRU MODE" with the following text: "Once IP Passthru is enabled via the physical switch on the router, IP Passthru will map the public IP address to the first client connected to the private LAN automatically. If there is more than one client connected to the private LAN, the MAC address of the client can be entered to ensure the correct client is mapped to the public IP address." Below this text are two radio buttons for "IP Passthru Mode": "Bind MAC Automatically" (selected) and "Bind MAC Manually". Below the radio buttons is a text input field for "Client MAC Address" with the value "00:26:B9:B3:E6:F2".

At the bottom of the page, there is a copyright notice: "Copyright © 2009 CradlePoint, Inc. All rights reserved." and the wipipe logo.

BASIC

4.2 IP Pass-Thru

IP Passthru allows a client connected to the private network to be configured automatically with the public IP address acquired from the ISP. The configuration is done by passing the client a DHCP lease with the public IP address when the WAN becomes connected. If there is more than one client connected to the private LAN, the user can bind the MAC address of a particular client to IP Passthru in order to ensure that client always receives the correct DHCP lease. Otherwise, the IP Passthru will pick the first device connected to the LAN to use IP Passthru.

4.2.1 IP Passthru Mode

IP Passthru Mode. Selecting **Bind MAC Automatically** will allow IP Passthru to automatically try to setup the client's connection to the Internet. This setting is the default setting, and should work in most cases. However, if there is more than one client connected to the private network, then selecting **Bind MAC Manually** will configure the router to only allow one particular client.

Client MAC Address. If you would like IP Passthru to be restricted to a particular client, enable this option and enter the client's MAC address into the association field. The router will grab the MAC address of the client connected to it during configuration. If this isn't the right address, enter the MAC of the correct device.

IP PASS-THRU

IP Pass-thru allows the public IP address acquired from the ISP to be mapped to a client on the private LAN. The public IP address is mapped automatically via DHCP protocol if the physical switch on the router is enabled. Otherwise, the router will give the client a private IP address to configure the router.

Save Settings
Don't Save Settings

IP PASSTHRU MODE

Once IP Passthru is enabled via the physical switch on the router, IP Passthru will map the public IP address to the first client connected to the private LAN automatically. If there is more than one client connected to the private LAN, the MAC address of the client can be entered to ensure the correct client is mapped to the public IP address.

IP Passthru Mode : Bind MAC Automatically
 Bind MAC Manually

Client MAC Address :

BASIC

4.3 DHCP (DHCP Settings)

DHCP stands for Dynamic Host Configuration Protocol. The DHCP section is where you configure the built-in DHCP Server to assign IP addresses to the computers and other devices on your local area network (LAN).

Use the DHCP sub-menu to configure the built-in DHCP Server to assign IP addresses to the computers and other devices on the local area network.

4.3.1 DHCP Server Settings

Enable DHCP Server. (Default: Enabled). Once your CBA750 router is properly configured and this option is enabled, the DHCP Server will manage the IP addresses and other network configuration information for computers and other devices connected to your Local Area Network. There is no need for you to do this yourself.

The computers (and other devices) connected to your LAN also need to have their TCP/IP configuration set to "DHCP" or "Obtain an IP address automatically".

When you set **Enable DHCP Server**, the following options are displayed.

DHCP IP Address Range. (Default: 192.168.0.100-192.168.0.199). This option defines the range of addresses available for the CBA750 to assign to an internal network. If there are any devices using static IP addresses, you must be sure the addresses do not fall within the range defined here. A Static IP address is one that is entered in manually on the device.

Example: The CBA750 uses an IP address of 192.168.0.1. A computer designated as a Web server has a static IP address of 192.168.0.3. Another computer is designated as an FTP server with a static IP address of 192.168.0.4. The starting IP address for the DHCP server needs to be 192.168.0.5 or above.

DHCP Lease Time. (Default: 1440 minutes [24 hours]). The amount of time a computer may have an IP address before it is required to renew the lease. The initial lease designates the amount of time before the lease expires. If the lease expires and the address is no longer needed, then another tenant may use the address. Units are in minutes, however a value of zero (0) means the lease never expires.

DHCP SETTINGS
Use this section to configure the built-in DHCP Server to assign IP addresses to the computers on your network.
[Save Settings] [Don't Save Settings]

DHCP SERVER SETTINGS
Use this section to configure the built-in DHCP Server to assign IP addresses to the computers on your network.

Enable DHCP Server:

DHCP IP Address Range: 192.168.0.100 to 192.168.0.199

DHCP Lease Time: 1440 (minutes)

Always broadcast: (compatibility for some DHCP Clients)

NetBIOS announcement:

Learn NetBIOS from WAN:

NetBIOS Scope: [] (optional)

NetBIOS node type:
 Broadcast only (use when no WINS servers configured)
 Point-to-Point (no broadcast)
 Mixed-mode (Broadcast then Point-to-Point)
 Hybrid (Point-to-Point then Broadcast)

Primary WINS IP Address: 0.0.0.0

Secondary WINS IP Address: 0.0.0.0

NUMBER OF DYNAMIC DHCP CLIENTS: 1

Hardware Address	Assigned IP	Hostname	Expires	Revoke	Release
00:1b:77:cd:c7:3a	192.168.0.199	16000	23 Hours 57 Minutes		

ADD DHCP RESERVATION

Enable:

Computer Name: [] << [Computer Name ▼]

IP Address: 0.0.0.0

MAC Address: 00:00:00:00:00:00

[Copy Your PC's MAC Address]

[Save] [Clear]

DHCP RESERVATIONS LIST

Enable	Computer Name	MAC Address	IP Address	Edit	Delete
--------	---------------	-------------	------------	------	--------

BASIC

Always Broadcast. If all the computers on the LAN successfully obtain their IP addresses from the router's DHCP server, this option can remain disabled. However, if one of the computers on the LAN fails to obtain an IP address, it may have an old DHCP client that incorrectly turns off the broadcast flag of DHCP packets. Enabling **Always Broadcast** will cause the router to always broadcast its responses to all clients, thereby working around the problem (at the cost of increased broadcast traffic on the LAN).

NetBIOS Announcement. Check this box to allow the DHCP Server to offer NetBIOS configuration settings to the LAN hosts. NetBIOS allows LAN hosts to discover all other computers within the network, e.g. within "Network Neighborhood."

Learn BIOS from WAN. If NetBIOS advertisement is switched on, WINS information will be learned from the WAN side, if available. Turn this setting off to configure manually.

NetBIOS Scope. This is an advanced setting and is normally left blank. This allows the configuration of a NetBIOS "domain" name under which network hosts operate. This setting has no effect if the **Learn NetBIOS information from WAN** is activated.

NetBIOS Node Type. Indicates how network hosts are to perform NetBIOS name registration and discovery. This setting has no effect if the **Learn**

NetBIOS information from WAN is activated.

- **Broadcast only.** This setting is useful where there are no WINS servers available, however, it is preferred you try **Mixed-Mode** operation first.
- **Point-to-Point** Mode. This setting indicates to use WINS servers ONLY. This setting is useful to force all NetBIOS operation to the configured WINS servers. You must have configured at least the primary WINS server IP to point to a working WINS server.
- **Mixed-Mode** (default). First broadcast operation is performed to register hosts and discover other hosts, if broadcast operation fails, WINS servers are tried, if any. This mode favors broadcast operation which may be preferred if WINS servers are reachable by a slow network link and the majority of network services such as servers and printers are local to the LAN.
- **Hybrid-State.** First WINS servers are tried, if any, followed by local network broadcast. This is generally the preferred mode if you have configured WINS servers.

Primary WINS IP Address. Configure the IP address of the preferred WINS server. WINS Servers store information regarding network hosts, allowing hosts to "register" themselves as well as discover other available hosts, e.g. for use in "Network Neighborhood." This setting has no effect if the **Learn NetBIOS information from WAN** is activated.

DHCP SERVER SETTINGS

Use this section to configure the built-in DHCP Server to assign IP addresses to the computers on your network.

Enable DHCP Server:

DHCP IP Address Range: to

DHCP Lease Time: (minutes)

Always broadcast: (compatibility for some DHCP Clients)

NetBIOS announcement:

Learn NetBIOS from WAN:

NetBIOS Scope: (optional)

NetBIOS node type : Broadcast only (use when no WINS servers configured)
 Point-to-Point (no broadcast)
 Mixed-mode (Broadcast then Point-to-Point)
 Hybrid (Point-to-Point then Broadcast)

Primary WINS IP Address:

Secondary WINS IP Address:

BASIC

Secondary WINS IP Address. Configure the IP address of the backup WINS server, if any. This setting has no effect if the [Learn NetBIOS information from WAN](#) is activated.

4.3.2 Number of Dynamic DHCP Clients.

This section displays what devices are currently leasing IP addresses. The DHCP Client table displays the number of clients that are receiving an IP address from the router, the computer name, MAC address, and IP address assigned to each computer. You can use the [Revoke IP address](#) option to take away a leased IP address from a client. This feature is useful for freeing up addresses when the client table is full or nearly full.

NUMBER OF DYNAMIC DHCP CLIENTS: 1					
Hardware Address	Assigned IP	Hostname	Expires	Revoke	Reserve
00:1b:77:cd:c7:3a	192.168.0.199	V6000	23 Hours 57 Minutes		

4.3.3 Add DHCP Reservation

Clients configured as DHCP can receive the same IP address all the time using this feature. This is almost the same as if a device has a static IP address except that it must still actually request an IP address from the CBA750. The CBA750 will provide the device the same IP address all the time. Servers on the network should either use a static IP address or this option.

Enable. Specifies whether the entry will be active or inactive.

Computer Name. You can assign a name for each computer that is given a reserved IP address. This may help you keep track of which computers are assigned this way. Example: [Game Server](#).

IP Address. The LAN address that you want to reserve.

MAC Address. To input the MAC address of your system, enter it manually or connect to the router's Web-Management interface from the system and click the [Copy Your PC's MAC Address](#) button.

A MAC address is usually located on a sticker on the bottom of a network device. The MAC address is comprised of twelve digits. Each pair of hexadecimal digits are usually separated by dashes or colons such as 00-0D-88-11-22-33 or 00:0D:88:11:22:33. If your network device is a computer and the network card is already located inside the computer, you can connect to the router from the computer and click the [Copy Your PC's MAC Address](#) button to enter the MAC address.

(continued)

ADD DHCP RESERVATION

Enable:

Computer Name: << Computer Name ▼

IP Address:

MAC Address:

[Copy Your PC's MAC Address](#)

[Save](#) [Clear](#)

BASIC

As an alternative, you can locate a MAC address in a specific operating system by following the steps below:

- Windows 98/Windows Me. Go to the computer's **Start** menu, select **Run**, type in **winipcfg**, and hit **Enter**. A popup window will be displayed. Select the appropriate adapter from the pull-down menu and you will see the Adapter Address. This is the MAC address of the device.
- Windows 2000/Windows XP/Windows 7. Go to the computer's Start menu, select **Programs**, select **Accessories**, and select **Command Prompt**. At the command prompt, type in **ipconfig /all** and hit **Enter**. The physical address displayed for the adapter connecting to the router is the MAC address.
- Mac OS X. Go to the computer's Apple Menu, select **System Preferences**, select **Network**, and select the **Ethernet Adapter** connecting to the router. Select the **Ethernet** button and the **Ethernet ID** will be listed. This is the same as the MAC.

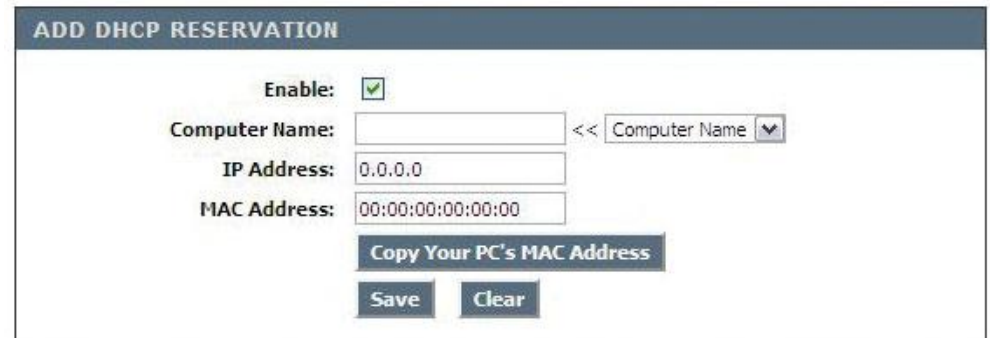

Save/Update. Record the changes you have made.

Clear. Re-initialize this area of the screen, discarding any changes you have made.

When you are done editing the settings, you must click the **Save Settings** button at the top of the page to make the changes effective and permanent.

Example: A DHCP reservation is used for making sure the router always gives a computer or device the same IP address. Let's say you have a Wi-Fi printer that you want to access via the Internet. You can connect to the CradlePoint Router from the Wi-Fi printer designated in this section.

1. Enter a designated IP address somewhere between the **Starting IP** and **Ending IP** addresses.
2. Click the **Copy Your PC's MAC Address** button and the CBA750 will detect the MAC address of the device and enter it automatically.
3. The **printer** name can be entered in for reference but is not required.
4. Click the **Save Settings** button at the top of the page.

The IP address will now only be assigned to the designated Wi-Fi printer and it will always receive the same IP address as long as it uses the same wireless adapter.

Default: No static DHCP clients.

NOTE: If you replace the wireless adapter in a computer that is using Static DHCP, you will need to click the Copy the PC's MAC Address button again because every wireless adapter has a unique MAC address. The same goes for any network device. If you replace a network device such as a print server, you will need to input the MAC address of the new print server into the Static DHCP configuration.

BASIC

4.3.4 DHCP Reservation List

The section shows the current DHCP Reservation List. Certain required routes are predefined and cannot be changed. Routes that you add can be changed by clicking the **Edit** icon or can be deleted by clicking the **Delete** icon.

When you click the **Edit** icon, the item is highlighted, and the **DHCP Reservation List** section is activated for editing. Click the **Enable** check box at the left to directly activate or de-activate the entry.

After you've completed all modifications or deletions, you must click the **Save Settings** button at the top of the page to save your changes. The router must reboot before new settings will take effect. You will be prompted **to Reboot the Device** or **Continue**. If you need to make additional settings changes, click **Continue**. If you are finished with all configuration settings, click the **Reboot the Device** button.

Default: empty list.

DHCP RESERVATIONS LIST					
Enable	Computer Name	MAC Address	IP Address	Edit	Delete

BASIC

4.4 Network

Use the Basic Network sub-menu to establish the local IP address for the router. These are the settings of the LAN (Local Area Network) interface for the router. The router's local network (LAN) settings are configured based on the IP Address and Subnet Mask assigned in this sub-menu. The IP address is also used to access this Web-based management Interface. It is recommended that you use the default settings if you do not have an existing network.

4.4.1 Router Settings.

Router IP Address. The IP address of your router on the local area network. Your local area network settings are based on the address assigned here. For example, **192.168.0.1**

Subnet Mask. The subnet mask of your router on the local area network.

Local Domain Name. This entry is optional. Enter a domain name for the local network. LAN computers will assume this domain name when they get an address from the router's built in DHCP server. So, for example, if you enter **mynetwork.net** here, and you have a LAN side laptop with a name of **chris**, that laptop will be known as **chris.mynetwork.net**. NOTE: the entered domain name can be overridden by the one obtained from the router's upstream DHCP server.

Enable DNS Relay. When **DNS Relay** is enabled, the router plays the role of a DNS server. DNS requests sent to the router are forwarded to the ISP's DNS server. This provides a constant DNS address that LAN computers can use, even when the router obtains a different DNS server address from the ISP upon re-establishing the WAN connection. You should disable DNS relay if you implement a LAN-side DNS server as a virtual server.

(continued)

NETWORK SETTINGS

Use this section to configure the internal network settings of your router. The IP Address that is configured here is the IP Address that you use to access the Web-based management interface. If you change the IP Address here, you may need to adjust your PC's network settings to access the network again.

Save Settings

Don't Save Settings

ROUTER SETTINGS

Use this section to configure the internal network settings of your router. The IP Address that is configured here is the IP Address that you use to access the Web-based management interface. If you change the IP Address here, you may need to adjust your PC's network settings to access the network again.

Router IP Address:

Subnet Mask:

Local Domain Name: (optional)

Enable DNS Relay:

RIP (ROUTING INFORMATION PROTOCOL)

Use this section to configure RIP for automatic management of routes.

Enable RIP:

BASIC

4.4.2 RIP (Router Information Protocol).

RIP is used to broadcast routing information among routers.

Enable RIP. Enable RIP if required by the ISP, if the LAN has multiple routers, or if the LAN has auto-IP devices. NOTE: When you select the **Enable RIP** check box, these additional features appear:

RIP Operating Mode. The CBA750 router supports both version 2 and version 1 of the RIP specification.

- V1. Use if none of the routers supports Version 2.
- V2 Broadcast. Use if some routers are capable of Version 2, but some are only capable of Version 1.
- V2 Multicast. Use if this is the only router on the LAN or if all the routers support Version 2.

Router Metric. The additional cost of routing a packet through this router. The normal value for a simple network is 1. This metric is added to routes learned from other routers; it is not added to static or system routes.

Act as Default Router. Make this router the preferred destination for packets that are not otherwise destined.

Accept WAN Updates. For security, disable this option unless required by the ISP.

RIP Password. RIP Version 2 supports the use of a password to limit access to routers through the RIP protocol. If the ISP or other LAN router requires a RIP password, enter the password here.

RIP (ROUTING INFORMATION PROTOCOL)

Use this section to configure RIP for automatic management of routes.

Enable RIP:

RIP Operating mode : V1 V2 Broadcast V2 Multicast

Router Metric

Act as default router:

Accept WAN updates:

RIP Password:

Confirm RIP Password:

BASIC

4.5 WAN Configuration

Use the WAN Configuration sub-menu to configure the network settings for the Wired and Cellular Modem WAN.

4.5.1 Cellular Modem PPP Authentication (optional).

Enter your Cellular Service Provider information in these three fields only if directed by your Cellular Service Provider.

Modem Interface. Modem interface is the physical port the modem is connected to. Select the appropriate port to change its settings.

Username. If required by your ISP, enter the username provided to you by your ISP. If not required by your ISP, leave this field blank.

Password. If required by your ISP, enter the password provided to you by your ISP. If not required by your ISP, leave this field blank.

Verify Password. Re-enter the password.

4.5.2 DNS Settings

Use the WAN Configuration sub-menu to configure the network settings for the Wired and Cellular Modem WAN (the first connected cellular handset or modem).

DNS Address. Select the **Get Automatically from ISP/Cellular Provider** radio button to acquire a DNS Address automatically from our ISP/Cellular Provider or select the **Use the Following DNS Servers** radio button to specify DNS Servers. NOTE: You would specify DNS Servers if you want Wi-Fi clients to access DNS servers that you use for customized addressing or if you have a local DNS server on your network.

Primary DNS Server. If you choose to use specify your DNS Servers, then enter the IP address of the server you want as your Primary DNS Server in this field.

Secondary DNS Server. If you choose to use specify your DNS Servers, then enter the IP address of the server you want as your Secondary DNS Server in this field.

WAN

Use this section to configure your Wired and Cellular Modem WAN Connection type. There are several wired WAN connection types to choose from: Static IP, DHCP, PPPoE, PPTP, and L2TP. If you are unsure of your connection method, please contact your Internet Service Provider.

Note : If using the PPPoE option, you will need to remove or disable any PPPoE client software on your computers.

CELLULAR MODEM PPP AUTHENTICATION (OPTIONAL)

Enter the information provided by your Cellular Service Provider.

Note: Fill in the following information ONLY if directed to by your Cellular Service Provider.

Modem Interface :

Username :

Password :

Verify Password :

Authentication Protocol :

DNS SETTINGS

DNS settings are automatically configured when your connection is established with the ISP. ISP DNS server setting can be overridden by entering in the DNS IP address below.

DNS Address :
 Get Automatically from ISP/Cellular Provider
 Use the following DNS Servers

Primary DNS Server :

Secondary DNS Server :

MODEM

5 MODEM TAB

The Modem Tab provides access to 4 sub-menus for displaying information and controlling settings for any attached phones or modems.

- Info
- Failover
- Settings
- Update

MODEM DIAGNOSTICS	
Name	Value
Manufacturer:	Sierra Wireless, Incorporated
Product:	Sierra Wireless USB 598
Carrier Status:	UP
ESN/IMEI:	609e9bf2
Connection Type:	CDMA
PRL Version:	60756
Service Display:	1xEV-DO, 1X
Signal Strength (%):	40
Signal Strength (dBm):	-100
PhysicalPort	USB1
Connection Status:	Connected

Copyright © 2009 CradlePoint, Inc. All rights reserved.

MODEM

5.1 Info

This page displays information about any attached phones or modems. The amount of information displayed depends on the particular phone/modem, but generally from a dozen to two dozen values are displayed. To understand what particular values such as "Home Address" or "Network Access Identifier" mean, please review information provided by your carrier. Of particular interest are the Signal Strength readings, these let you know the quality of the attached phone/modem connection to your carrier. You may be able to move the location of the router or modem to increase your Signal Strength. Please note that if any of the values are displayed in red, you will need to correct the condition before you can access the WAN link across that phone/modem.

If your phone/modem does not support reading diagnostics such as Signal Strength while it is connected to the carrier's network, a "Refresh" button will show up on the page. If you press this button, any current data connection will be terminated, new readings will be presented, and a new data connection will be made. This is equivalent to pressing the router's external Signal Strength (SGNL) button. Again, note that the data connection will be lost and any attached devices will be momentarily interrupted if they are accessing the WAN using the phone/modem.

MODEM DIAGNOSTICS		
	Name	Value
Manufacturer:		Sierra Wireless, Incorporated
Product:		Sierra Wireless USB 598
ESN/IMEI:		609e9bf2
Connection Type:		CDMA
PRL Version:		60756
Service Display:		1xEV-DO, 1X
Signal Strength (%):		40
Signal Strength (dBm):		-102
PhysicalPort		USB1
Connection Status:		offline

MODEM

5.2 Failover

The CBA750 can establish an uplink via any modems plugged into the USB or ExpressCard ports. Although all of these devices may be plugged in, only one of them may establish a link at a time. If the WAN connection fails the router will automatically attempt to bring up a new link on another device. This feature is called failover. You can also manually disconnect and re-connect specific ports using icons in the **Control** column. The priority table can be saved permanently via the **Save** button. Priority changes take effect immediately even if they are not saved.

5.2.1 WAN Interfaces

This section allows you to:

- Change the failover order of devices (aka interfaces)
- Monitor their status
- Take the active link down
- Bring a link up on another device

The device at the top of the list has the highest priority. This is the device which the router will attempt to start when it boots up. If the link cannot be brought up on this device, or if it fails after boot up, the router will attempt to bring the link up on the next available device. Whenever a link fails on a device, the router will always move down to the next device down in the list, and wrap around again to the top.

Slot. The slot is the physical port the modem is plugged into.

Device. This shows a description of the device.

Status. This is the link status of a device, which is one of the following:

- **Ready.** This means the device is plugged in an available but not active.
- **Establishing.** This means the router is attempting to bring up the link over the device.
- **Signal Strength Mode (Established).** This means the link is up and running on the device and the signal strength is shown.
- **Suspended.** This means the router will not attempt to bring up the link over the device until a timer expires. This only applies to modems, which must conform to carrier specifications about how often they may attempt to connect to the network. The timeout depends on how many previous connection attempts have failed in a row. *(continued)*

FAILOVER

Configure the priority of the existing WAN interfaces.

Save Settings

Don't Save Settings

WAN INTERFACES

Slot	Device	Status	Control	Priority
ExpressCard	-	-		↑ ↓
USB1	Sierra Wireless USB 598	Signal Strength Mode (40%)	⊘	↑ ↓
USB2	-	-		↑ ↓
USB3	-	-		↑ ↓

MODEM

Control. The device which has an active link will show a circle-and-slash icon. If you click on this icon the router will bring the link down. It will not automatically failover in this case. If you bring the link down, the modem will remain disconnected until you use the control to enable it again. The router will not attempt to automatically connect to a modem that has been manually disconnected.

All other available devices will have a check mark icon. If you click on this icon the router will attempt to bring the link up over this device. If necessary, it will first bring the active link down. Failover will proceed to the next device down on the list.

Priority. Click on the up-arrow and down-arrow icons to change the priority of the device.

MODEM

5.3 Settings

Advanced modem settings is a method for customizing a limited set of modem settings. Currently, this includes controlling the AT dial commands and entering a modem password if required by the device.

5.3.1 Global Mode Settings

This section allows for customization of Global Modem Settings.

Reconnect Mode. Typically modem connections are not always on. The CradlePoint router allows you to set the reconnection mode. The settings are:

- **Always on.** A connection to the Internet is always maintained.
- **On demand.** A connection to the Internet is made as needed.
- **Manual.** You have to open up the Web-based management interface and click the Connect button manually any time that you wish to connect to the Internet.

Maximum Idle Time. Time interval (in minutes) the machine can be idle before the modem connection is disconnected. The Maximum Idle Time value is only used for the **On demand** and **Manual** reconnect modes.

5.3.2 Global Connection Settings

This section is for changing the connection settings for any modem plugged into the router.

Aggressive Modem Reset. Some modems tend to become unresponsive or unable to maintain a connection for a long period of time. This setting uses more aggressive techniques to get the modem to reset and reconnect.

(continued)

GLOBAL MODE SETTINGS

Reconnect Mode : Always on On demand Manual

Maximum Idle Time : (minutes, 5-120)

GLOBAL CONNECTION SETTINGS

Aggressive Modem Reset :

Verify Connection :

MODEM 4G AUTO-RECONNECT POLICY FOR DUAL 3G/4G MODEMS

If a 4G connection is dropped, or can't be established, the router will use 3G mode instead. The settings below tell the MBR1200 when it should automatically retry the 4G connection. If a 4G connection cannot be made, the 3G connection will be reestablished or resumed.

Note: Some dual mode modems do not allow simultaneous 3G and 4G connections. For these types of modems, service to the internet will be interrupted for several seconds while trying to upgrade the connection to 4G.

Retry 4G Automatically : More Often (based on data rate)
 Less Often (based on data rate)
 More Often (based on timer)
 Less Often (based on timer)
 Custom
 Never

MODEM SPECIFIC SETTINGS

Modem Interface :

AT Dial Script :

Modem Password :

Verify Modem Password :

Make SIM PIN Permanent :

SIM PIN :

NOTE: You will need to re-plug your modem for the PIN or APN settings to take effect.

Access Point Name (APN) :

WiMAX Realm Select : <<

MODEM

Verify Connection. This setting causes the router to periodically verify that the modem connection to the Internet is still active. Due to the nature of cellular networks, there are times the modem will report it is still active but data will not be able to flow across the connection. This setting enables the router to detect this condition (either actively or passively) and restart the connection if there is a problem.

Timeout. This is how often the router will check to see if the modem connection is still active. It does this by seeing if any new data was received over the connection during the previous Timeout seconds. This is the passive mode of connection verification.

Enable Ping on Idle. This setting configures the router to send a ping packet when no data was received during the previous timeout period. If the connection is still active, a response should be received. This is the active mode of connection verification.

Ping Target. This setting controls which IP address will be pinged.

GLOBAL CONNECTION SETTINGS	
Aggressive Modem Reset :	<input type="checkbox"/>
Verify Connection :	<input checked="" type="checkbox"/>
Timeout :	60 (seconds)
Enable Ping on Idle :	<input type="checkbox"/>
Ping Target :	0.0.0.0

MODEM

5.3.3 Modem 4G Auto-Reconnect Policy for DUAL 3G/4G Modems

If a 4G connection is dropped, or can't be established, the router will use 3G mode instead. The settings tell the CBA750 when it should automatically retry the 4G connection. If a 4G connection cannot be made, the 3G connection will be reestablished or resumed.

Retry 4G Automatically.

- More Often (based on data rate)
- Less Often (based on data rate)
- More Often (based on timer)
- Less Often (based on timer)
- Never (Default)
- Custom

Data Rate Threshold (KB/Sec). Select Data Rate Threshold.

Duration Threshold (seconds). Select Duration Threshold.

If the rate of data on the 3G connection falls below **Data Rate Threshold** for longer than the **Duration Threshold**, the router will attempt to upgrade the 4G connection automatically.

If the **Data Rate Threshold** is set to a negative value, the router will attempt to upgrade the 4G connection automatically every **Duration Threshold Seconds**.

NOTE: Some dual mode modems do not allow simultaneous 3G and 4G connections. For these types of modems, service to the internet will be interrupted for several seconds while trying to upgrade the connection to 4G.

MODEM 4G AUTO-RECONNECT POLICY FOR DUAL 3G/4G MODEMS

If a 4G connection is dropped, or can't be established, the router will use 3G mode instead. The settings below tell the MBR1200 when it should automatically retry the 4G connection. If a 4G connection cannot be made, the 3G connection will be reestablished or resumed.

Note: Some dual mode modems do not allow simultaneous 3G and 4G connections. For these types of modems, service to the internet will be interrupted for several seconds while trying to upgrade the connection to 4G.

- Retry 4G Automatically :**
- More Often (based on data rate)
 - Less Often (based on data rate)
 - More Often (based on timer)
 - Less Often (based on timer)
 - Custom
 - Never

Data Rate Threshold (KB/sec):

Duration Threshold (seconds):

If the rate of data on the 3G connection falls below Data Rate Threshold for longer than Duration Threshold, the router will attempt to upgrade the 4G connection automatically.

If Data Rate Threshold is set to a negative value, the router will attempt to upgrade the 4G connection automatically every Duration Threshold seconds.

MODEM

5.3.4 Modem Specific Settings

This section allows customization of the AT dial commands

Modem Interface. Use the drop down menu to specify which modem interface you want to adjust settings for (i.e., [USB1](#), [USB2](#), [USB3](#), [Cardbus](#), [ExpressCard](#)).

AT Dial Script. Enter the AT commands to be used in establishing a network connection. Each command must be entered on a separate line. All command responses must include **OK**, except the final command response, which must include **CONNECT**.

Example:

AT

AT+CGDCONT=2,"IP","isp.cingular"

ATDT*99***2#

Modem Password. Enter the modem password, if required

Verify Modem Password. Enter the modem password again to ensure it was entered correctly.

Disable Automatic Dialing. If you check this box then a modem won't dial unless you start it manually. Otherwise a modem will dial automatically (if it is the highest priority available device).

Make SIM PIN Permanent. If **Make SIM PIN Permanent** is selected the entered PIN will be remembered between reboots. If a modem is plugged in when this is selected the router will make a permanent association between the PIN and the current modem. When a PIN is associated with a modem the PIN will be automatically entered for you when the associated modem is plugged in. If you choose Permanent PIN but there is no modem plugged in at the time then no modem is associated with any PIN. The next time a modem is plugged in and a valid PIN is entered for the modem the router will remember that association.

SIM PIN. Enter your **PIN number** here. If Permanent PIN is not selected, this PIN number will be used with any modem plugged in until the router is rebooted.

Access Point Name (APN). Some wireless carriers provide multiple Access Point Names that a modem can connect to. If you wish to specify an APN, enter it into this field. Some examples of APN are [isp.cingular](#), [ecp.tmobile.com](#) and [vpn.com](#). This APN will be set in the first profile position (see [Modem Diagnostics](#)). The modem must be removed and reinserted for this change to take affect (or the router rebooted). This APN is associated with the modem in the interface referred to in the **Modem Interface** drop down menu, so multiple APNs may be entered.

(continued)

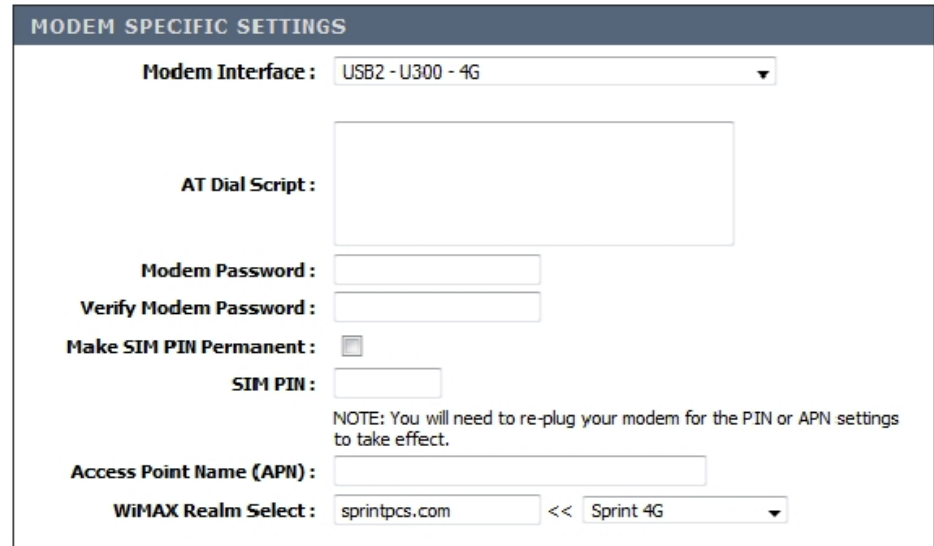

MODEM

Band Select. This function is currently supported only on Sierra Wireless modems. It allows you to select specific frequency bands to use, either GSM (2.5G network) or WCDMA (3G network) settings, or the use of "Autoband", which is automatic band selection. Depending on your location, different network selections will be shown based on the bands the particular modem supports and the router recognizes. If you select one of the WCDMA settings such as "WCDMA/GSM NA (North America)", the modem will use the 3G network in preference to the 2.5G network. *This change is persistent and stays with the modem, even if you unplug it and move it to a PC.* The band currently selected by the modem will be marked with an asterisk (*) in the drop-down list.

WiMAX Realm Select. If you are using a 4G modem you must select the WiMAX realm. This allows you to connect to your carrier: ie. Sprint.

MODEM SPECIFIC SETTINGS

Modem Interface : USB2 - U300 - 4G ▾

AT Dial Script :

Modem Password :

Verify Modem Password :

Make SIM PIN Permanent :

SIM PIN :

NOTE: You will need to re-plug your modem for the PIN or APN settings to take effect.

Access Point Name (APN) :

WiMAX Realm Select : sprintpcs.com << Sprint 4G ▾

MODEM

5.4 Update

Some modems can be activated and updated while plugged into the router. Activation and updates vary by modem model and service provider. All supported methods are displayed. If no methods are displayed for your device you will need to activate and update your device externally.

MODEM UPDATE

Activate or update connected Modems and Devices. Only supported updates are displayed

All activation and update commands will leave the device in a *User Stopped* disconnected state. You can replug the device or reconnect it via the *Device Info Connect* button after running the update.

DEVICE

ESN/IMEI: 609e9bf2

PRL Version: 60756

Activation State: Active

Auto Configuration:

Activate, Reactivate or Upgrade Configuration:

Preferred Roaming List (PRL) Update:

Update PRL:

TOOLS

6 TOOLSTAB

The Advanced tab provides access to 7 sub-menus for administering advanced functions/tasks important in enterprises and larger organizations. Specifically, for IT organizations that use a number of CBA750 units to provide wireless data connectivity for employees, the Tools tab allows you to enable the remote devices to be an extension of your network, and abide by the policies set within your department. Included are a number of features that allow the unit to provide security, supportability, and EVDO handset behavior regardless where a remote employee is located.

- Admin
- Firmware
- Managed Services
- SysLog
- System
- System Check
- Time

The screenshot displays the Cradlepoint web interface for the CBA750 device. At the top, the Cradlepoint logo is visible. Below it is a navigation bar with tabs for BASIC, MODEM, TOOLS (which is selected), STATUS, and HELP. On the left side, there is a 'Tools' sidebar menu with options: ADMIN, FIRMWARE, MANAGED SERVICES, SYSLOG, SYSTEM, SYSTEM CHECK, and TIME. The main content area is titled 'ADMINISTRATOR SETTINGS' and contains the following information:

- ADMINISTRATOR SETTINGS**: A section explaining that the 'admin' account can access the management interface. It notes that by default, no password is configured and strongly recommends creating one for security. Below this text are two buttons: 'Save Settings' and 'Don't Save Settings'.
- ADMIN PASSWORD**: A section titled 'Please enter the same password into both boxes, for confirmation.' It features two password input fields labeled 'Password' and 'Verify Password', both showing masked characters (dots).
- SYSTEM NAME**: A section with a 'Gateway Name' input field containing the text 'CradlePoint: CBA750'.

At the bottom of the page, there is a copyright notice: 'Copyright © 2009 CradlePoint, Inc. All rights reserved.' and the 'wipipe' logo.

TOOLS

6.1 Admin (Administrative Settings).

Use the Admin sub-menu to set a password for access to the Web-based management. The default Admin and Internet Access (User) passwords are the last six characters of the MAC address (NOTE: all letters in the MAC address should be entered as lower case). This screen may also be used by the individual who first activates the unit.

6.1.1 Admin Password

Password. Type password in this field that you want to use to grant access to Web based management interface. Default: Last 6 characters of the CBA750's MAC address.

NOTE: all letters in the MAC address should be entered as lower case.

Verify Password. Re-type the password to ensure it was entered correctly.

6.1.2 System Name

Gateway Name. The name of the router can be changed here. Default (CradlePoint: CBA750).

When you are done editing the settings, you must click the **Save Settings** button at the top of the page to make the changes effective and permanent.

ADMINISTRATOR SETTINGS

The 'admin' account can access the management interface.

By default there is no password configured. It is highly recommended that you create a password to keep your router secure.

Save Settings
Don't Save Settings

ADMIN PASSWORD

Please enter the same password into both boxes, for confirmation.

Password :

Verify Password :

SYSTEM NAME

Gateway Name :

TOOLS

6.2 Firmware

Use the Firmware Upgrade sub-menu to update your router to the latest firmware to improve functionality and performance. To check for the latest firmware, click the **Check Online Now** button.

6.2.1 Firmware Information

This section displays the Current Firmware Version and the Latest Firmware Version. To check for the latest version, click the **Check Online Now for Latest Firmware Version** button. To verify the latest firmware version, the CBA750 checks the Internet.

6.2.2 Manually Upgrade Firmware

Upload Firmware. To update the firmware, follow these steps:

1. Click the **Browse** button to locate the update file on your computer.
2. Once you have found the file to be used, click the **Upload** button to start the firmware update process.
3. Wait for the router to reboot.
4. Confirm updated firmware revision on the **Status → Device Info** submenu.

6.2.3 Manually Upgrade WIMAX Modem Driver File

Upload WiMAX Modem Driver File. To update the driver follow these steps:

1. Click the **Browse** button to locate the update file on your computer.
2. Once you have found the file to be used, click the **Upload** button to start the driver update process.
3. Wait for the modem to reboot.
4. Confirm updated firmware revision on the **Tools → Firmware** submenu.

When you are done editing the settings, you must click the **Save Settings** button at the top of the page to make the changes effective and permanent.

(continued)

FIRMWARE

Use the Firmware section to install the latest firmware to improve functionality and performance.

To check for the latest firmware, click the [Check Online Now...] button.

Save Settings
Don't Save Settings

FIRMWARE INFORMATION

Current Firmware Version : 1.6.9
Current Firmware Date : 2010/03/04

Check Online Now for Latest Firmware Version

MANUALLY UPGRADE FIRMWARE

Note: Some firmware upgrades reset the configuration options to the factory defaults. Before performing an upgrade, be sure to save the current configuration from the Tools → System screen.

Upload Firmware : Browse...

Upload

MANUALLY UPGRADE WIMAX MODEM DRIVER FILE

Note: This upgrade will remove the previous WiMAX modem driver file.

WiMAX Modem Driver Version : 5.2.206

Upload WiMAX Modem Driver File : Browse...

Upload

FIRMWARE UPGRADE NOTIFICATION OPTIONS

Automatically Check Online for Latest Firmware Version :

TOOLS

6.2.4 Firmware Upgrade Notification Options

Automatically Check Online for Latest Firmware Version. When this option is enabled, your router will check online periodically to see if there is a newer version of firmware available. When new firmware is available, you will see an additional button that initiates a one button update. Simply click the button to download and update the router in one click.



6.2.5 Firmware Update Notes

When a new firmware update file is loaded into the router, the following checks are made to insure that the new file is correct.

1. Before the new firmware update is loaded into its permanent location (the NVRAM), it is first downloaded into a temporary (RAM) area for checking.
2. The downloaded file is first checked against a checksum to insure that the entire file has been downloaded and no data errors have occurred.
3. Each firmware file is encoded with a special product identification, which must match the current code in the router. If the two identifiers match the update is allowed to proceed. If either of these checks fail, the firmware update file is rejected and a failure message given to the user.
4. After the new firmware file passes both of these checks, the code is written to the permanent location (NVRAM). Power to the unit must be maintained during this critical step; do not turn off unit. As the router writes the new code into the permanent location (NVRAM), the user is presented with a screen on the browser which counts down for 60 seconds. After the 60-second countdown, the unit automatically reboots and reinitializes.

TOOLS

6.2.6 Firmware Update via the USB

The CBA750 supports software upgrades via the USB port. A USB storage device (thumb drive) is preloaded with the new software .bin file.

Requirements:

- CradlePoint CBA750 Binary firmware file (i.e. u_CBA750_2010_03_23.bin) From: <http://www.cradlepoint.com/support/CBA750>
- 4G Modem Binary firmware file (i.e. u_modem_5_2_206.bin) From: <http://www.cradlepoint.com/support/CBA750>
- CradlePoint CBA750
- USB “Thumb drive” mass storage device formatted FAT or FAT32.

Router Firmware Update – USB Procedure:

- Remove the date code from the binary file. Example: u_CBA750_2010_01_22.bin to **u_CBA750.bin**.
- Copy the u_CBA750.bin file to the USB Thumb Drive. This must be in the root not in a folder.
- Power on a CBA750 and wait for the POWER light to go solid green.
- Plug-in the USB Thumb Drive into the USB port on the CBA750
- The EC light will come on and blink while it is reading the binary file off the USB Thumb Drive
- When the EC light goes solid for 3 seconds or more, pull the USB thumb drive.
- At this point, the router will read the file, error check it and will load it. The router will reboot itself and will be running the new firmware

NOTE: If the file is corrupt, the CBA750 will reboot and will not load the new firmware. It is recommend that when you are doing these en mass, the first few are manually checked by logging into the router with a computer and going to <http://192.168.0.1>, login with the default password, and then check the “Status” tab which will show the current router firmware version. The default password is the last 6 character of the MAC address, which is located on a sticker on the bottom.

Modem File Update – USB Procedure:

- Remove the date code from the binary file. Example: u_modem_2009_11_16 to **u_modem.bin**.
- Copy the u_modem.bin file to the USB Thumb Drive. This must be in the root not in a folder.
- Power on a CBA750 and wait for the WLAN and POWER lights to go solid green.
- Plug-in the USB Thumb Drive into the USB port on the CBA750
- The EC light will come on and blink while it is reading the binary file off the USB Thumb Drive
- When the EC light goes solid for 3 seconds or more, pull the USB thumb drive.
- At this point, the router will read the file, error check it and will load it. The router will reboot itself and will be running the new firmware

NOTE: If the file is corrupt, the CBA750 will reboot and will not load the modem file. It is recommend that when you are doing these en mass, the first few are manually checked by logging into the router with a computer and going to <http://192.168.0.1>, login with the default password, and then check the “Status” tab which will show the current router firmware version. The default password is the last 6 character of the MAC address, which is located on a sticker on the bottom.

TOOLS

6.3 Managed Services

Use the Managed Services sub-menus to securely control your routers from anywhere on the Internet. You can manage their configuration, change their f/w, monitor their status and view their stored logs from any Internet-connected web browser. When this feature is enabled the router will automatically attempt to contact the management server whenever its WAN link comes up. All session management is done over the WAN link using an SSL-secured connection.

In order for the router to establish a session it must be registered with the server. Contact CradlePoint for details on how to create an account.

Enable Managed Services. Tell the router to attempt to establish a management session over the active WAN link.

Session Retry. If a router is not yet registered with the server it will periodically retry to establish a session. This setting controls how long it will wait between retry attempts.

Registration URL. If you have contacted Cradlepoint about registering your router, you may have received an email with a URL link. Paste that link here, and the next time your router fails to start a session it will register via this link.

When you are done editing the settings, you must click the **Save Settings** button at the top of the page to make the changes effective and permanent.

MANAGED SERVICES

Enable and configure remote managed services on this router.

Save Settings
Don't Save Settings

MANAGED SERVICES CONFIGURATION

Enable and configure remotely managed services here.

Enable Managed Services :

Session Retry : (minutes)

Registration URL :

TOOLS

6.4 Syslog

Use the SYSLOG sub-menu to enable archive of log files to a Syslog Server.

Enable Logging to Syslog Server. (Default: off) Enable this option if you have a syslog server currently running on the LAN and wish to send log messages to it.

Syslog Server IP Address. Enter the LAN IP address of the Syslog Server.

When you are done editing the settings, you must click the **Save Settings** button at the top of the page to make the changes effective and permanent.

SYSLOG

The SysLog options allow you to send log information to a SysLog Server.

Save Settings
Don't Save Settings

SYSLOG SETTINGS

Enable Logging To Syslog Server:

Syslog Server IP Address: << Computer Name ▼

TOOLS

6.5 System (System Settings)

Use the System Settings sub-menu to control to **Reboot the Device** function or to restore the router to the factory default settings.

WARNING: Restoring the unit to the factory default settings will overwrite and erase any custom settings you have implemented that change the original factory default settings.

6.5.1 System Settings

Save Configuration. Click to save configuration information to a file on a local hard drive or any other target you choose.

Restore Configuration from File. Reads all configuration information from a Save Configuration file.

Restore to Factory Defaults. This option will restore all configuration settings back to the factory defaults. Any settings that have not been saved will be lost. If you want to save your router configuration settings, you can do so from the **Tools** → **Admin** sub-menu.

Reboot the Device. This will restart the router. Useful for restarting when you are not near the device. When you click the **Reboot the Device** button, you will be prompted to **Save Configuration**, which saves the configuration as described in **Save to Local Hard Drive**. This option preserves any custom settings you have implemented.

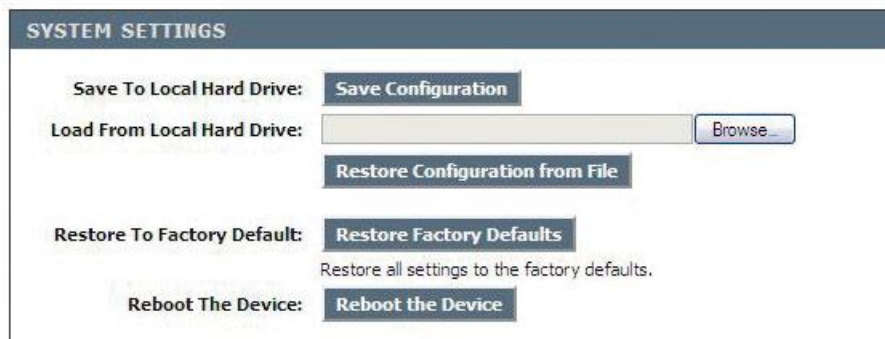
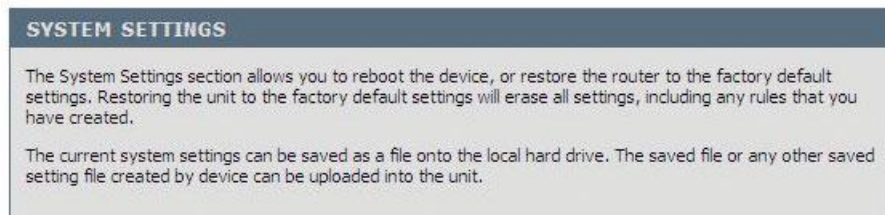

TOOLS

6.6 System Check (Ping Test)

Use the System Check sub-menu as a diagnostic tool to check connectivity from the router to another computer. This function can be used to verify a working connection across the WAN network or the local network. NOTE: the ping target must be configured to respond to ICMP ping requests.

6.6.1 Ping Test

Host Name or IP Address. Enter either the IP address of the target computer or enter its fully qualified domain name.

- Ping. Start Pinging the specified host
- Stop. The host is pinged repeatedly until you click the **Stop** button.

6.6.2 Ping Result

Displays the results of the ping test. The ping test is an ICMP echo protocol. It's used to test response and path to a remote computer system, i.e., a ping to a URL "www.xxxxx.com" will tell you if there is a path and if the remote computer is responding. NOTE: Not all devices respond to pings.

Example:

- Host Name or IP Address:

www.whitehouse.gov

- Ping Result

Please wait, resolving www.whitehouse.gov....

Resolved to 205.161.7.102.

Response from 205.161.7.102 received in 7 milliseconds.

Response from 205.161.7.102 received in 6 milliseconds.

Response from 205.161.7.102 received in 7 milliseconds.

User stopped ping.

The screenshot shows a web interface for a Ping Test. It consists of three main sections:

- PING TEST**: A header section with a dark blue background. Below it, a light gray box contains the text: "Ping Test sends "ping" packets to test a computer on the Internet."
- PING TEST**: A second header section with a dark blue background. Below it, a white box contains the label "Host Name or IP Address:" followed by a text input field. To the right of the input field are two buttons: "Ping" and "Stop".
- PING RESULT**: A third header section with a dark blue background. Below it, a white box contains the instruction: "Enter a host name or IP address above and click 'Ping'"

TOOLS

6.7 Time

Use the Time Configuration sub-menu to configure, update, and maintain the correct time on the internal system clock. The time can be configured manually or a network time server can be selected and the time updated via the Network Time Protocol (NTP).

6.7.1 Time Configuration.

Current Router Time. Displays the day, date and local time used by the CBA750.

Time Zone. Select the local time zone.

Enable Daylight Saving. Check this option to adjust for daylight savings time.

Daylight Saving Offset. Select the time offset for daylight savings time.

Daylight Savings Dates. Set the month, week, day of week and time for the CBA750 to switch to/from Daylight Savings Time.

6.7.2 Automatic Time Configuration

Enabling this option allows the CBA750 to contact network time servers to automatically adjust the CBA750 clock. If you are using schedules or logs, this is the best way to ensure that the schedules and logs are accurate.

Enable NTP Server. Select this option if you want the router's clock synchronized to a Time Server over the Internet.

NTP Server Used. Select a Time Server for synchronization. You can type in the address of a time server or select one from the drop down menu.

(continued)

TIME

The Time Configuration option allows you to configure, update, and maintain the correct time on the internal system clock. From this section you can set the time zone that you are in and set the NTP (Network Time Protocol) Server. Daylight Saving can also be configured to automatically adjust the time when needed.

TIME CONFIGURATION

Current Router Time : Thu Apr 29 2010 12:58:46 AM

Time Zone : (GMT-07:00) Mountain Time (US/Canada) ▼

Enable Daylight Saving :

Daylight Saving Offset : +1:00 ▼

Daylight Saving Dates :

	Month	Week	Day of Week	Time
DST Start	Mar ▼	2nd ▼	Sun ▼	2 am ▼
DST End	Nov ▼	1st ▼	Sun ▼	2 am ▼

AUTOMATIC TIME CONFIGURATION

Enable NTP Server :

NTP Server Used : << Select NTP Server ▼

SET THE DATE AND TIME MANUALLY

Date And Time :

Year	2010 ▼	Month	Apr ▼	Day	29 ▼		
Hour	12 ▼	Minute	54 ▼	Second	56 ▼		AM ▼

TOOLS

6.7.3 Set the Date and Time Manually

If you do not have the NTP Server option in effect, you can either manually set the time for your router here or you can click the **Copy Your Computer's Time Settings** button to copy the time from the computer you are using.

NOTE: Be sure the computer's time is set correctly.

WARNING: If the router loses power for any reason, it cannot keep its clock running and will not have the correct time when it is started again. To maintain the correct time for schedules and logs, either you must enter the correct time after you restart the router or you must enable the NTP Server option.

When you are done editing the settings, you must click the **Save Settings** button at the top of the page to make the changes effective and permanent.

SET THE DATE AND TIME MANUALLY

Date And Time :

Year	<input type="text" value="2010"/>	Month	<input type="text" value="Apr"/>	Day	<input type="text" value="29"/>	
Hour	<input type="text" value="12"/>	Minute	<input type="text" value="54"/>	Second	<input type="text" value="56"/>	<input type="text" value="AM"/>

7 STATUS TAB

The Status tab provides information about the current configuration settings of the CBA750 router via 3 sub-menus:

- Device Info
- Logs
- Statistics

The screenshot shows the Cradlepoint web interface for the CBA750 router. At the top, there are navigation tabs: BASIC, MODEM, TOOLS, STATUS (selected), and HELP. Below the tabs is a sidebar with 'Status' selected, and sub-menus for 'DEVICE INFO', 'LOGS', and 'STATISTICS'. The main content area is divided into several sections:

- DEVICE INFORMATION:** A note stating that all Internet and network connection details are displayed on this page, including the firmware version (1.6.9, 2010/03/04).
- GENERAL:** Shows the current time (Sat Jan 31 2004 11:43:57 AM) and the firmware version (1.6.9, 2010/03/04).
- WAN:** Displays connection details for the WAN interface (USB1). It shows a signal strength indicator, connection type (PPP), network status (Established), and connection up time (0 Days, 0 Hour 14 Min 39 Sec). There are 'Connect' and 'Disconnect' buttons. Below this, it lists authentication and security settings (None), IP address (68.27.93.170), subnet mask (255.255.255.248), default gateway (68.27.93.171), primary DNS server (68.28.58.92), and secondary DNS server (68.28.50.91).
- LAN:** Displays LAN interface settings, including MAC address (00:30:44:09:7B:39), IP address (192.168.0.1), subnet mask (255.255.255.0), and DHCP server status (Enabled).
- CURRENT DHCP RESERVATIONS:** A table showing reserved IP addresses and their corresponding names and MAC addresses.

IP Address	Name (if any)	MAC
192.168.0.199	DRush-E6500	00:26:b9:b3:e6:f2

7.1 Device Info

The Device Information sub-menu displays your Router settings. Options cannot be changed from this sub-menu. They can only be monitored.

NOTE: Some browsers have limitations that make it impossible to update the WAN status display when the status changes. Some browsers require that you refresh the display to obtain updated status. Some browsers report an error condition when trying to obtain WAN status.

7.1.1 General

Time. Displays the time and date that the router is set to.

Firmware Version. Displays the currently loaded firmware version.

7.1.2 WAN (Primary and Secondary Interface(s))

The information displayed will be for the currently active WAN connection. To change the failover priorities of the various WAN connections or to manually connect or disconnect a WAN connection go to the **Modem → Failover** sub-menu. If the connection is DHCP, clicking the **DHCP Release** button unassigns the router's IP address. The router will not respond to IP messages from the WAN side until you click the **DHCP Renew** button or power-up the router again. Clicking the **DHCP Renew** button requests a new IP address from the ISP's server.

If the connection is via a modem, clicking the **Disconnect** button will cause the modem to hang up, and it will not dial again (regardless of the **Reconnect Mode** from the Global Settings section of the Modem Settings page) unless you re-plug it or click the **Connect** button.

Port. USB1, USB2, USB3, or Express Card.

Signal Strength. Strength of wireless signal.

Connection Type. The Internet connection type that is being used.

Network Status. Network is Connected, Establishing, Suspended, or Established. *(continued)*

DEVICE INFORMATION

All of your Internet and network connection details are displayed on this page. The firmware version is also displayed here.

GENERAL

Time : Sat Jan 31 2004 11:40:30 AM
Firmware Version : **1.6.9, 2010/03/04**

WAN

Port : USB1

Signal Strength :

Connection Type : PPP

Network Status : Established

Connection Up Time : 0 Days, 0 Hour 11 Min 09 Sec

Authentication & Security : None

IP Address : 68.27.93.170

Subnet Mask : 255.255.255.248

Default Gateway : 68.27.93.171

Primary DNS Server : 68.28.58.92

Secondary DNS Server : 68.28.50.91

LAN

MAC Address : 00:30:44:09:78:39

IP Address : 192.168.0.1

Subnet Mask : 255.255.255.0

DHCP Server : Enabled

CURRENT DHCP RESERVATIONS

IP Address	Name (if any)	MAC
192.168.0.199	DRush-E6500	00:26:b9:b3:e6:f2

Connection Uptime. Amount of time the connection has been successfully connected.

Authentication & Security. Type of Authentication & Security in place.

MAC Address. The MAC address that is seen over the Internet.

IP Address. The IP address being used on the WAN port.

Subnet Mask. The subnet mask used on the WAN port.

Default Gateway. The default gateway of the WAN port.

Primary DNS Server. The Primary DNS Server address.

Secondary DNS Server. The Secondary DNS Server address.

7.1.3 LAN

This area of the screen reflects configuration settings from the **Basic → Network** sub-menu.

MAC Address. The MAC address displayed for your wired network. It is the factory-assigned identifier of the LAN ports.

IP Address. IP Address of the router.

Subnet Mask. Subnet of the router.

DHCP Server. DHCP Server is Enabled or Disabled.

(continued)

DEVICE INFORMATION

All of your Internet and network connection details are displayed on this page. The firmware version is also displayed here.

GENERAL

Time : Sat Jan 31 2004 11:40:30 AM
 Firmware Version : **1.6.9, 2010/03/04**

WAN

Port : USB1
 Signal Strength : 
 Connection Type : PPP
 Network Status : Established
 Connection Up Time : 0 Days, 0 Hour 11 Min 09 Sec

Authentication & Security : None
 IP Address : 68.27.93.170
 Subnet Mask : 255.255.255.248
 Default Gateway : 68.27.93.171
 Primary DNS Server : 68.28.58.92
 Secondary DNS Server : 68.28.50.91

LAN

MAC Address : 00:30:44:09:7B:39
 IP Address : 192.168.0.1
 Subnet Mask : 255.255.255.0
 DHCP Server : Enabled

CURRENT DHCP RESERVATIONS

IP Address	Name (if any)	MAC
192.168.0.199	DRush-E6500	00:26:b9:b3:e6:f2

7.1.4 Current DHCP Reservation

This area of the screen continually updates to show all DHCP enabled computers and devices connected to the LAN side of your router. The detection "range" is limited to the address range as configured in DHCP Server. Computers that have an address outside of this range will not show. If the DHCP Client (i.e. a computer configured to Automatically obtain an address) supplies a Host Name then that will also be shown. Any computer or device that has a static IP address that lies within the detection "range" may show, however its host name will not.

CURRENT DHCP RESERVATIONS		
IP Address	Name (if any)	MAC
192.168.0.199	SE-Desktop	00:30:44:03:41:99

7.2 Logs

The Logs sub-menu allows you to view the router logs. The router automatically logs (records) events of possible interest in its internal memory. If there isn't enough internal memory for all events, logs of older events are deleted but logs of the latest events are retained. You can decide what types of events you want to view and the level of the events to view. This router also has external Syslog Server support so you can send the log files to a computer on your network that is running a Syslog utility.

7.2.1 Log Options

What to View. You can select the types of messages that you want to display from the log:

- System
- Bridge Status

View Levels. You can choose from three levels of message importance:

- Critical
- Warning
- Informational

Apply Log Settings Now. Filters the log results so that only the selected options appear.

7.2.2 Log Details

Refresh. Updates the log details on the screen so it displays any recent activity.

Clear. Clears all of the log contents.

Save Log. This option will save the router to a log file on your computer.

LOGS

The Logs page allows you to view the logs and define what types of events you want to view and the event levels to view. This router also has external syslog server support so you can send the log files to a computer on your network that is running a syslog utility.

LOG OPTIONS

What to View : System Bridge Status

View Levels : Critical Warning Informational

Apply Log Settings Now

LOG DETAILS

107 Log Entries:

Priority	Time	Message
[INFO]	Sat Jan 31 11:33:42 2004	Blocked incoming TCP packet from 68.28.31.153:4201 to 68.27.93.170:63631 as RST:ACK received but there is no active connection
[INFO]	Sat Jan 31 11:32:50 2004	Blocked outgoing TCP packet from 192.168.0.199:63631 to 68.28.31.153:4201 as PSH:ACK received but there is no active connection
[INFO]	Sat Jan 31 11:32:40 2004	Blocked incoming TCP packet from 74.125.19.83:443 to 68.27.93.170:63872 as FIN:ACK received but there is no active connection
[INFO]	Sat Jan 31 11:32:26 2004	Above message repeated 5 times
[INFO]	Sat Jan 31 11:30:48 2004	Blocked incoming TCP packet from 74.125.19.189:443 to 68.27.93.170:63865 as PSH:ACK received but there is no active connection
[INFO]	Sat Jan 31 11:30:45 2004	Blocked incoming TCP packet from 74.125.19.100:80 to 68.27.93.170:63868 as PSH:ACK received but there is no active connection
[INFO]	Sat Jan 31 11:30:40 2004	Blocked incoming TCP packet from 204.228.223.6:443 to 68.27.93.170:63828 as RST:ACK received but there is no active connection
[INFO]	Sat Jan 31 11:30:40 2004	Blocked incoming TCP packet from 204.228.223.6:443 to 68.27.93.170:63831 as RST:ACK received but there is no active connection

7.3 Statistics (Traffic Statistics)

The Statistics (Traffic Statistics) sub-menu displays basic statistics for the LAN and WAN interfaces.

7.3.1 Traffic Statistics

Refresh Statistics. Updates the screen with the latest router statistics.

Clear Statistics. Clears all of the values on the screen.

7.3.2 LAN and WAN Statistics

Sent KiloBytes. The number of KiloBytes transmitted.

Received KiloBytes. The number of KiloBytes received.

Sent Packets. The number of transmit packets sent.

Received Packets. The number of receive packets not dropped.

Sent Packets Dropped. The number of packets that were dropped while being sent, due to errors, collisions, or router resource limitations.

Received Packets Dropped. The number of packets that were dropped while being received, due to errors, collisions, or router resource limitations.

TRAFFIC STATISTICS

Traffic Statistics display receive and transmit packets passing through your router.

Refresh Statistics
Clear Statistics

LAN STATISTICS

Sent KiloBytes : 3739	Received KiloBytes : 1692
Sent Packets : 9072	Received Packets : 8662
Sent Packets Dropped : 3	Received Packets Dropped : 0

WAN DEVICE #1(USB1 PORT) STATISTICS

Sent KiloBytes : 190	Received KiloBytes : 318
Sent Packets : 1028	Received Packets : 990
Sent Packets Dropped : 0	Received Packets Dropped : 0

8 GLOSSARY

802.11

A family of specifications for wireless local area networks (WLANs) developed by a working group of the Institute of Electrical and Electronics Engineers (IEEE).

Access Control List

ACL. This is a database of network devices that are allowed to access resources on the network.

Access Point

AP. Device that allows wireless clients to connect to it and access the network.

ActiveX

A Microsoft specification for the interaction of software components.

Ad-hoc network

Peer-to-Peer network between wireless clients.

Address Resolution Protocol

ARP. Used to map MAC addresses to IP addresses so that conversions can be made in both directions.

ADSL

Asymmetric Digital Subscriber Line.

Advanced Encryption Standard

AES. Government encryption standard.

Alphanumeric

Characters A-Z and 0-9.

Antenna

Used to transmit and receive RF signals.

AppleTalk

A set of Local Area Network protocols developed by Apple for their computer systems.

AppleTalk Address Resolution Protocol

AARP. Used to map the MAC addresses of Apple computers to their AppleTalk network addresses, so that conversions can be made in both directions.

Application layer

7th Layer of the OSI model. Provides services to applications to ensure that they can communicate properly with other applications on a network.

ASCII

American Standard Code for Information Interchange. This system of characters is most commonly used for text files.

Attenuation

The loss in strength of digital and analog signals. The loss is greater when the signal is being transmitted over long distances.

Authentication

To provide credentials, like a Password, in order to verify that the person or device is really who they are claiming to be.

Automatic Private IP Addressing

APIPA. An IP address that a Windows computer will assign itself when it is configured to obtain an IP address automatically but no DHCP server is available on the network.

Backward Compatible

The ability for new devices to communicate and interact with older legacy devices to guarantee interoperability.

Bandwidth

The maximum amount of bytes or bits per second that can be transmitted to and from a network device.

Basic Input/Output System

BIOS. A program that the processor of a computer uses to startup the system once it is turned on.

Baud

Data transmission speed.

Beacon

A data frame by which one of the stations in a Wi-Fi network periodically broadcasts network control data to other wireless stations.

Bit rate

The amount of bits that pass in given amount of time.

Bit/sec

Bits per second.

BOOTP

Bootstrap Protocol. Allows for computers to be booted up and given an IP address with no user intervention.

Bottleneck

A time during processes when something causes the process to slowdown or stop all together.

Broadband

A wide band of frequencies available for transmitting data.

Broadcast

Transmitting data in all directions at once.

Browser

A program that allows you to access resources on the web and provides them to you graphically.

Cable modem

A device that allows you to connect a computer up to a coaxial cable and receive Internet access from your Cable provider.

CardBus

A newer version of the PC Card or PCMCIA interface. It supports a 32-bit data path, DMA, and consumes less voltage.

CAT 5

Category 5. Used for 10/100 Mbps or 1Gbps Ethernet connections.

Client

A program or user that requests data from a server.

Collision

When do two devices on the same Ethernet network try and transmit data at the exact same time.

Cookie

Information that is stored on the hard drive of your computer that holds your preferences to the site that gave your computer the cookie.

Data

Information that has been translated into binary so that it can be processed or moved to another device.

Data Encryption Standard

Uses a randomly selected 56-bit key that must be known by both the sender and the receiver when information is exchanged.

Data-Link layer

The second layer of the OSI model. Controls the movement of data on the physical link of a network.

Database

Organizes information so that it can be managed updated, as well as easily accessed by users or applications.

DB-25

A 25-pin male connector for attaching External modems or RS-232 serial devices.

DB-9

A 9-pin connector for RS-232 connections

dBd

Decibels related to dipole antenna.

dB_i

Decibels relative to isotropic radiator.

dBm

Decibels relative to one milliwatt.

Decrypt

To unscramble an encrypted message back into plain text.

Default

A predetermined value or setting that is used by a program when no user input has been entered for this value or setting.

Demilitarized zone

DMZ: A single computer or group of computers that can be accessed by both users on the Internet as well as users on the Local Network, but that is not protected by the same security as the Local Network.

DHCP

Dynamic Host Configuration Protocol: Used to automatically assign IP addresses from a predefined pool of addresses to computers or devices that request them.

Digital certificate

An electronic method of providing credentials to a server in order to have access to it or a network.

Direct Sequence Spread Spectrum

DSSS: Modulation technique used by 802.11b wireless devices.

DMZ

“Demilitarized Zone”. A computer that logically sits in a “no-mans-land” between the LAN and the WAN. The DMZ computer trades some of the protection of the router’s security mechanisms for the convenience of being directly addressable from the Internet.

DNS

Domain Name System: Translates Domain Names to IP addresses.

Domain name

A name that is associated with an IP address.

Download

To send a request from one computer to another and have the file transmitted back to the requesting computer.

DSL

Digital Subscriber Line. High bandwidth Internet connection over telephone lines.

Duplex

Sending and Receiving data transmissions at the same time.

Dynamic DNS service

Dynamic DNS is provided by companies to allow users with Dynamic IP addresses to obtain a Domain Name that will always be linked to their changing IP address. The IP address is updated by either client software running on a computer or by a router that supports Dynamic DNS, whenever the IP address changes.

Dynamic IP address

IP address that is assigned by a DHCP server and that may change. Cable Internet providers usually use this method to assign IP addresses to their customers.

EAP

Extensible Authentication Protocol.

Email

Electronic Mail is a computer-stored message that is transmitted over the Internet.

Encryption

Converting data into cyphertext so that it cannot be easily read.

Ethernet

The most widely used technology for Local Area Networks.

Fiber optic

A way of sending data through light impulses over glass or plastic wire or fiber.

File server

A computer on a network that stores data so that the other computers on the network can all access it.

File sharing

Allowing data from computers on a network to be accessed by other computers on the network with different levels of access rights.

Firewall

A device that protects resources of the Local Area Network from unauthorized users outside of the local network.

Firmware

Programming that is inserted into a hardware device that tells it how to function.

Fragmentation

Breaking up data into smaller pieces to make it easier to store.

FTP

File Transfer Protocol. Easiest way to transfer files between computers on the Internet.

Full-duplex

Sending and Receiving data at the same time.

Gain

The amount an amplifier boosts the wireless signal.

Gateway

A device that connects your network to another, like the Internet.

Gbps

Gigabits per second.

Gigabit Ethernet

Transmission technology that provides a data rate of 1 billion bits per second.

GUI

Graphical user interface.

H.323

A standard that provides consistency of voice and video transmissions and compatibility for video conferencing devices.

Half-duplex

Data cannot be transmitted and received at the same time.

Hashing

Transforming a string of characters into a shorter string with a predefined length.

Hexadecimal

Characters 0-9 and A-F.

Hop

The action of data packets being transmitted from one router to another.

Host

Computer on a network.

HTTP

Hypertext Transfer Protocol is used to transfer files from HTTP servers (web servers) to HTTP clients (web browsers).

HTTPS

HTTP over SSL is used to encrypt and decrypt HTTP transmissions.

Hub

A networking device that connects multiple devices together.

ICMP

Internet Control Message Protocol.

IEEE

Institute of Electrical and Electronics Engineers.

IGMP

Internet Group Management Protocol is used to make sure that computers can report their multicast group membership to adjacent routers.

IIS

Internet Information Server is a WEB server and FTP server provided by Microsoft.

IKE

Internet Key Exchange is used to ensure security for VPN connections.

Infrastructure

In terms of a wireless network, this is when wireless clients use an Access Point to gain access to the network.

Internet

A system of worldwide networks which use TCP/IP to allow for resources to be accessed from computers around the world.

Internet Explorer

A World Wide Web browser created and provided by Microsoft.

Internet Protocol

The method of transferring data from one computer to another on the Internet.

Internet Protocol Security

IPsec provides security at the packet processing layer of network communication.

Internet Service Provider

An ISP provides access to the Internet to individuals or companies.

Intranet

A private network.

Intrusion Detection

A type of security that scans a network to detect attacks coming from inside and outside of the network.

IP

Internet Protocol.

IP address

A 32-bit number, when talking about Internet Protocol Version 4, that identifies each computer that transmits data on the Internet or on an Intranet.

IPsec

Internet Protocol Security.

IPX

Internetwork Packet Exchange is a networking protocol developed by Novell to enable their Netware clients and servers to communicate.

ISP

Internet Service Provider.

Java

A programming language used to create programs and applets for web pages.

Kbps

Kilobits per second.

Kbyte

Kilobyte.

L2TP

Layer 2 Tunneling Protocol.

LAN

Local Area Network.

Latency

The amount of time that it takes a packet to get from the one point to another on a network. Also referred to as delay.

LED

Light Emitting Diode.

Legacy

Older devices or technology.

Local Area Network

LAN. A group of computers in a building that usually access files from a server.

LPR/LPD

“Line Printer Requestor”/“Line Printer Daemon”. A TCP/IP protocol for transmitting streams of printer data.

MAC Address

A unique hardware ID assigned to every Ethernet adapter by the manufacturer.

Mbps

Megabits per second.

MDI

Medium Dependent Interface is an Ethernet port for a connection to a straight-through cable.

MDIX

Medium Dependent Interface Crossover is an Ethernet port for a connection to a crossover cable.

MIB

Management Information Base is a set of objects that can be managed by using SNMP.

Modem

A device that Modulates digital signals from a computer to an analog signal in order to transmit the signal over phone lines. It also Demodulates the analog signals coming from the phone lines to digital signals for your computer.

MPPE

Microsoft Point-to-Point Encryption is used to secure data transmissions over PPTP connections.

MTU

Maximum Transmission Unit is the largest packet that can be transmitted on a packet-based network like the Internet.

Multicast

Sending data from one device to many devices on a network.

NAT

Network Address Translation allows many private IP addresses to connect to the Internet, or another network, through one IP address.

NetBEUI

NetBIOS Extended User Interface is a Local Area Network communication protocol. This is an updated version of NetBIOS.

NetBIOS

Network Basic Input/Output System.

Netmask

Determines what portion of an IP address designates the Network and which part designates the Host.

Network Interface Card

NIC. A card installed in a computer or built onto the motherboard that allows the computer to connect to a network.

Network Layer

The third layer of the OSI model which handles the routing of traffic on a network.

Network Time Protocol

Used to synchronize the time of all the computers in a network.

NIC

Network Interface Card.

NTP

Network Time Protocol.

OFDM

Orthogonal Frequency-Division Multiplexing is the modulation technique for both 802.11a and 802.11g.

OSI

Open Systems Interconnection is the reference model for how data should travel between two devices on a network.

OSPF

Open Shortest Path First is a routing protocol that is used more than RIP in larger scale networks because only changes to the routing table are sent to all the other routers in the network as opposed to sending the entire routing table at a regular interval, which is how RIP functions.

Password

A sequence of characters that is used to authenticate requests to resources on a network.

Personal Area Network

The interconnection of networking devices within a range of 10 meters.

Physical layer

The first layer of the OSI model. Provides the hardware means of transmitting electrical signals on a data carrier.

Ping

A utility program that verifies that a given Internet address exists and can receive messages. The utility sends a control packet to the given address and waits for a response.

PoE

Power over Ethernet is the means of transmitting electricity over the unused pairs in a category 5 Ethernet cable.

POP3

Post Office Protocol 3 is used for receiving email.

Port

A logical channel endpoint in a network. A computer might have only one physical channel (its Ethernet channel) but can have multiple ports (logical channels) each identified by a number.

PPP

Point-to-Point Protocol is used for two computers to communicate with each other over a serial interface, like a phone line.

PPPoE

Point-to-Point Protocol over Ethernet is used to connect multiple computers to a remote server over Ethernet.

PPTP

Point-to-Point Tunneling Protocol is used for creating VPN tunnels over the Internet between two networks.

Preamble

Used to synchronize communication timing between devices on a network.

QoS

Quality of Service.

RADIUS

Remote Authentication Dial-In User Service allows for remote users to dial into a central server and be authenticated in order to access resources on a network.

Reboot

To restart a computer and reload its operating software or firmware from nonvolatile storage.

Rendezvous

Apple's version of UPnP, which allows for devices on a network to discover each other and be connected without the need to configure any settings.

Repeater

Retransmits the signal of an Access Point in order to extend its coverage.

RIP

Routing Information Protocol is used to synchronize the routing table of all the routers on a network.

RJ-11

The most commonly used connection method for telephones.

RJ-45

The most commonly used connection method for Ethernet.

RS-232C

The interface for serial communication between computers and other related devices.

RSA

Algorithm used for encryption and authentication.

Server

A computer on a network that provides services and resources to other computers on the network.

Session key

An encryption and decryption key that is generated for every communication session between two computers.

Session layer

The fifth layer of the OSI model which coordinates the connection and communication between applications on both ends.

Simple Mail Transfer Protocol

Used for sending and receiving email.

Simple Network Management Protocol

Governs the management and monitoring of network devices.

SIP

Session Initiation Protocol. A standard protocol for initiating a user session that involves multimedia content, such as voice or chat.

SMTP

Simple Mail Transfer Protocol.

SNMP

Simple Network Management Protocol.

SOHO

Small Office/Home Office.

SPI

Stateful Packet Inspection.

SSH

Secure Shell is a command line interface that allows for secure connections to remote computers.

SSID

Service Set Identifier is a name for a wireless network.

Stateful Packet Inspection

A feature of a firewall that monitors outgoing and incoming traffic to make sure that only valid responses to outgoing requests are allowed to pass through the firewall.

Subnet mask

Determines what portion of an IP address designates the Network and which part designates the Host.

Syslog

System Logger -- a distributed logging interface for collecting in one place the logs from different sources. Originally written for UNIX, it is now available for other operating systems, including Windows.

TCP

Transmission Control Protocol.

TCP Raw

A TCP/IP protocol for transmitting streams of printer data.

TCP/IP

Transmission Control Protocol/Internet Protocol.

TFTP

Trivial File Transfer Protocol is a utility used for transferring files that is simpler to use than FTP but with less features.

Throughput

The amount of data that can be transferred in a given time period.

Traceroute

A utility displays the routes between your computer and specific destination.

UDP

User Datagram Protocol.

Unicast

Communication between a single sender and receiver.

Universal Plug and Play

UPnP. A standard that allows network devices to discover each other and configure themselves to be a part of the network.

Update

To install a more recent version of a software or firmware product.

Upgrade

To install a more recent version of a software or firmware product.

Upload

To send a request from one computer to another and have a file transmitted from the requesting computer to the other.

UPnP

Universal Plug and Play.

URL

Uniform Resource Locator is a unique address for files accessible on the Internet.

USB

Universal Serial Bus.

UTP

Unshielded Twisted Pair.

Virtual Private Network

VPN: A secure tunnel over the Internet to connect remote offices or users to their company's network.

VLAN

Virtual LAN.

Voice over IP

Sending voice information over the Internet as opposed to the PSTN

VoIP

Voice over IP.

Wake on LAN

Allows you to power up a computer through its Network Interface Card.

WAN

Wide Area Network.

WCN

Windows Connect Now. A Microsoft method for configuring and bootstrapping wireless networking hardware (access points) and wireless clients, including PCs and other devices.

WDS

Wireless Distribution System. A system that enables the interconnection of access points wirelessly.

Web browser

A utility that allows you to view content and interact with all of the information on the World Wide Web.

WEP

Wired Equivalent Privacy is security for wireless networks that is supposed to be comparable to that of a wired network.

Wi-Fi

Wireless Fidelity. Used to describe any of the 802.11 wireless networking specifications.

Wi-Fi Protected Access

An updated version of security for wireless networks that provides authentication as well as encryption.

Wide Area Network

The larger network that your LAN is connected to, which may be the Internet itself, or a regional or corporate network.

Wireless (Wi-Fi) LAN

Connecting to a Local Area Network over one of the 802.11 wireless standards.

Wireless ISP

WISP. A company that provides a broadband Internet connection over a wireless connection.

WISP

Wireless Internet Service Provider.

WLAN

Wireless Local Area Network.

WPA

Wi-Fi Protected Access. A Wi-Fi security enhancement that provides improved data encryption, relative to WEP.

xDSL

A generic term for the family of digital subscriber line (DSL) technologies, such as ADSL, HDSL, RADSL, and SDSL.

Yagi antenna

A directional antenna used to concentrate wireless signals on a specific location.

9 APPENDIX

9.1 Regulatory Information

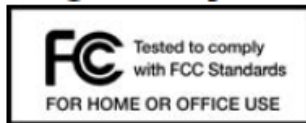

This equipment has been tested and found to comply with the limits for a Class B digital device, pursuant to Part 15 of the FCC Rules. These limits are designed to provide reasonable protection against harmful interference in a residential installation. This equipment generates, uses, and can radiate radio frequency energy and, if not installed and used in accordance with the instructions, may cause harmful interference to radio communications. This device must accept any interference received, including interference that may cause undesired operation. However, there is no guarantee that interference will not occur in a particular installation. If this equipment does cause harmful interference to radio or television reception, which can be determined by turning the equipment off and on, the user is encouraged to try and correct the interference by one or more

of the following measures:

- *Reorient or relocate the receiving antenna.*
- *Increase the separation between the equipment and receiver.*
- *Connect the equipment into an outlet on a circuit different from that to which the receiver is connected.*
- *Consult the dealer or an experienced radio or television technician for help.*

Changes or modifications not expressly approved by CradlePoint, Inc. could void the user's authority to operate the product.

Radio Frequency Interference Requirement - Canada

This Class B digital apparatus complies with Canadian ICES-003.

Cet appareil numérique de la classe B est conforme à la norme NMB-003 du Canada.

9.2 Warranty Information

CradlePoint, Inc. warrants this product against defects in materials and workmanship to the original purchaser (or the first purchaser in the case of resale by an authorized distributor) for a period of one (1) year from the date of shipment. This warranty is limited to a repair or replacement of the product, at CradlePoint's discretion.

Within thirty (30) days of receipt should the product fail for any reason other than damage due to customer negligence, purchaser may return the product to the point of purchase for a full refund of the purchase price.

If the purchaser wishes to upgrade or convert to another CradlePoint, Inc. product within the thirty (30) day period, purchaser may return the product and apply the full purchase price toward the purchase of the other product. Any other return will be subject to CradlePoint, Inc.'s existing return policy.

IN NO EVENT SHALL CRADLEPOINT'S LIABILITY EXCEED THE PRICE PAID FOR THE PRODUCT FROM DIRECT, INDIRECT, INCIDENTAL, SPECIAL, OR CONSEQUENTIAL DAMAGES RESULTING FROM THE USE OF THE PRODUCT, ITS USER INTERFACE SOFTWARE, OR ITS DOCUMENTATION.

CradlePoint makes no warranty or representation, expressed, implied, or statutory, with respect to its products or the contents or use of this documentation and all user interface software, and specifically disclaims its quality, performance, merchantability, or fitness for any particular purpose. CradlePoint reserves the right to revise or update its products, software, or documentation without obligation to notify any individual or entity.

9.3 Specifications

MODEL NAME

CBA750 Mobile Broadband Adapter

WAN (MOBILE BROADBAND)

3G/4G via Three (4) Modem Ports (3 USB 2.0, 1 ExpressCard);

LAN

1 Ethernet LAN Ports (10/100)

ANTENNAS

internal WiFi antennas (300+ yards range), external antenna ports for optional antennas providing additional distance and performance

BUTTONS / SWITCHES

Activation, Signal Strength Display, Reset, Configuration Mode/IP Pass-Through Mode, ExpressCard Lock

LED INDICATORS

Power, Ethernet LAN Activity, USB Modem Activity, ExpressCard Modem Activity, Signal Strength Indicator, Data Transmission, Failover, Higher Network Speeds, Power-over-Ethernet, Mode, Attention

POWER

PoE Class 3 (Compatible with 802.3af of Class 3 powered devices) or 12V DC 1.5A

DIMENSIONS

9.05" x 5.11" x 1.57" (230mm x 130mm x 40mm)

ENVIRONMENTAL TEMPERATURE

0°C to 40°C (32°F to 104°F) Operating -20°C to 70°C (-4°F to 158°F) Storage

RELATIVE HUMIDITY

10% - 85% Operating; 5% - 90% Storage

CERTIFICATIONS

CE

DETAILS

- Drop-In, Easy To Use Adapter - No Software To Install
- Compatible with 100+ EVDO, HSPA, and WiMAX Cellular Network Devices
- Power-over-Ethernet allows you to place the CBA750 at the Best Location
- 10/100 BASE-T Ethernet Port
- IEEE 802.3u Compliant, Static IP, PPPoE, PPTP, and L2TP Connection Types
- Universal Plug-n-Play and Application-Level Gateway for Internet Applications: Email, FTP, Gaming, Remote Desktop, NetMeeting, Telnet, SSH, and SCP
- Flash Memory for Firmware Upgrades and Save/Restore Settings
- Easy Local or Remote Management via HTTP, HTTPS
- Compatible with WiPipe Central Managed Services



<http://www.cradlepoint.com/>

Copyright © 2010 by CradlePoint, Inc. All rights reserved.